



## OPERATING INSTRUCTIONS

### KATflow 230

Advanced Clamp-On Ultrasonic Flowmeter



# KATflow 230

## Operating Instructions

Official Katronic distributor for the Benelux :

**U-F-M b.v.**

Argon 3  
4751 XC Oud Gastel  
The Netherlands

Tel. +31 (0)165 855 655  
E-mail [info@u-f-m.nl](mailto:info@u-f-m.nl)  
Web [www.u-f-m.nl](http://www.u-f-m.nl)

TABLE OF CONTENTS

1	SAFETY INSTRUCTIONS, LEGAL REQUIREMENTS, WARRANTY, RETURN POLICY	5	4.5.5	Dual-channel measurement screen	30
1.1	Symbols	5	4.5.6	“Math” display	30
1.2	Safety instructions	5	4.5.7	Data logger	30
1.3	Warranty	6	5	COMMISSIONING	31
1.4	Return policy	6	5.1	Menu structure	31
1.5	Legislative requirements	6	5.2	Output configuration	39
2	INTRODUCTION	7	5.2.1	Serial interface	40
2.1	Clamp-on transit-time flowmeter	7	5.2.2	Analogue current output 0/4 ... 20 mA	40
2.2	Measuring principle	7	5.2.3	Digital relay output	40
3	INSTALLATION	8	5.2.4	Digital open-collector output	41
3.1	Unpacking and storage	8	5.3	Input configuration	41
3.1.1	Unpacking	8	5.3.1	Pt 100 inputs	41
3.1.2	Storage	8	5.4	Outputs using serial expansion box and modular cards	42
3.1.3	Identification of components	9	5.4.1	Modbus RTU	43
3.2	System configuration	10	5.4.2	HART® compatible output	43
3.3	Clamp-on sensor installation	11	5.4.3	Analogue current output 0/4 ... 20 mA	44
3.3.1	Acoustic propagation	11	5.4.4	Analogue voltage output 0 ... 10 V	44
3.3.2	Straight pipe lengths	11	5.4.5	Analogue frequency output (passive)	45
3.4	Installation location	11	5.4.6	Digital open-collector output	45
3.5	Pipe preparation	14	5.4.7	Digital relay output	46
3.6	Sensor mounting configurations and separation distance	15	5.5	Inputs using serial expansion box and modular cards	46
3.6.1	Reflection Mode	15	5.5.1	Pt 100 inputs	46
3.6.2	Diagonal Mode	15	5.5.2	Analogue current input 0/4 ... 20 mA	47
3.6.3	Transducer separation distance	15	5.6	Temperature compensation	47
3.7	Flowmeter installation	16	5.7	Heat quantity measurement	47
3.7.1	Outline dimensions	16	5.8	Sound velocity measurement	47
3.7.2	Electrical connections	18	5.9	Dual-channel flow calculations	47
3.8	Clamp-on sensor mounting	19	5.10	Wall thickness measurement	48
3.8.1	Acoustic coupling gel	19	5.10.1	Wall Thickness Gauge Wizard	48
3.8.2	Correct positioning of the sensors	20	5.11	Scope function	48
3.8.3	Sensor mounting with fixtures and chains	21	5.12	KATdata+ software	48
4	OPERATION	22	6	MAINTENANCE	49
4.1	Switching On/Off	22	6.1	Service/Repair	49
4.2	Battery charging	22	7	TROUBLESHOOTING	50
4.3	Keypad and display	23	7.1	Measurement difficulties and error messages	50
4.3.1	Keypad key functions	23	7.2	Data download difficulties	52
4.3.2	Display icons and functions	25	8	TECHNICAL DATA	53
4.4	Quick Setup Wizard	26	8.1	Sound speed of selected pipe materials	53
4.5	Measurement	28	8.2	Technical data of selected fluids	54
4.5.1	Main process value display	28	8.3	Dependence between temperature and sound speed in water	57
4.5.2	Three-line display	28			
4.5.3	Diagnostic display	29			
4.5.4	Totaliser	29			

# KATflow 230

## TABLE OF CONTENTS

9	SPECIFICATION	60	9.7	Process inputs	62
9.1	General	60	9.8	Process outputs	62
9.2	Flowmeter	60	9.9	Sensors: K1L, K1N, K1E	63
9.3	Quantity and units of measurement	61	9.10	Sensors: K4L, K4N, K4E	63
9.4	Internal data logger	61	10	INDEX	64
9.5	Communication	61	11	APPENDIX A – Certificate of Conformity	65
9.6	KATdata+ software	61	12	Notes	66

## SAFETY INSTRUCTIONS, LEGAL REQUIREMENTS, WARRANTY, RETURN POLICY

## 1 SAFETY INSTRUCTIONS, LEGAL REQUIREMENTS, WARRANTY, RETURN POLICY

## 1.1 Symbols



Danger

This symbol represents an immediate hazardous situation which could result in serious injury, death or damage to the equipment. Where this symbol is shown, do not use the equipment further unless you have fully understood the nature of the hazard and have taken the required precautions.



Attention

This symbol indicates important instructions which should be respected in order to avoid damaging or destroying the equipment. Follow the precautions given in these instructions to avoid the hazard. Call our service team if necessary.



Call service

Where this symbol is shown call our service team for advice if necessary.



Note

This symbol indicates a note or detailed setup tip.

**ESC** Operator key

Operator keys are printed in bold typeface.

## 1.2 Safety instructions

- Do not install, operate or maintain this flowmeter without reading, understanding and following these operating instructions, otherwise injury or damage may result.
- Study these operating instructions carefully before the installation of the equipment and keep them for future reference.
- Observe all warnings, notes and instructions as marked on the packaging, on the equipment, and detailed in the operating instructions.
- Do not use the instrument under wet conditions with the battery cover removed or opened.
- Follow the unpacking, storage and preservation instructions to avoid damage to the equipment.
- Install the equipment and cabling securely and safely according to the relevant regulations.
- If the product does not operate normally, please refer to the service and troubleshooting instructions, or contact Katronic for help.

# KATflow 230

## SAFETY INSTRUCTIONS, LEGAL REQUIREMENTS, WARRANTY, RETURN POLICY

### 1.3 Warranty

- Any product purchased from Katronic is warranted in accordance with the relevant product documentation and as specified in the sales contract provided. This is subject to the condition that it has been used for the purpose for which it has been designed and operated as outlined in these operating instructions. Misuse of the equipment will immediately revoke any warranty given or implied.
- Responsibility for suitability and intended use of this ultrasonic flowmeter rests solely with the user. Improper installation and operation of the flowmeter may lead to a loss of warranty.
- Please note that there are no operator-serviceable parts inside the equipment. Any unauthorised interference with the product will invalidate the warranty.

### 1.4 Return policy

If the flowmeter has been diagnosed to have a problem, it can be returned to Katronic for repair using the Customer Return Note (CRN) attached to the Appendix of this manual. Katronic regret that for health and safety reasons we cannot accept the return of the equipment unless accompanied by the completed CRN.

### 1.5 Legislative requirements



The flowmeter is designed to meet the safety requirements in accordance with sound engineering practice. It has been tested and has left the factory in a condition in which it is safe to operate. The equipment is in conformity with the statutory requirements of the EC directive and complies with applicable regulations and standards for electrical safety EN 61010 and electromagnetic compatibility EN 61326. A CE Declaration of Conformity has been issued in that respect, a copy of which can be found in the Appendix of these operating instructions.

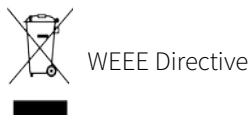

The Waste Electrical and Electronic Equipment Directive (WEEE Directive 2012/19/EU) aims to minimise the impact of electrical and electronic goods on the environment by increasing re-use and recycling and by reducing the amount of WEEE going to landfill. It seeks to achieve this by making producers responsible for financing the collection, treatment, and recovery of waste electrical equipment, and by obliging distributors to allow consumers to return their waste equipment free of charge. Katronic offers its customers the possibility of returning unused and obsolete equipment for correct disposal and recycling. The dustbin symbol indicates that when the last user wishes to discard this product, it must be sent to appropriate facilities for recovery and recycling. By not discarding this product along with other household-type waste, the volume of waste sent to incinerators or landfills will be reduced and natural resources will be conserved. Please use the Customer Return Note (CRN) in the Appendix for return to Katronic.



All products manufactured by Katronic are compliant with the relevant aspects of the RoHS Directive.

## 2 INTRODUCTION

### 2.1 Clamp-on transit-time flowmeter

The KATflow 230 is a portable, battery operated ultrasonic flowmeter employing clamp-on sensors for the measurement of liquids in full, enclosed pipes. Flow measurements can be undertaken without interruption of the process or interference with the integrity of the pipeline. The clamp-on sensors are attached to the outside of the pipes. The KATflow 230 uses ultrasonic signals for measurement of the flow, employing the transit-time method.

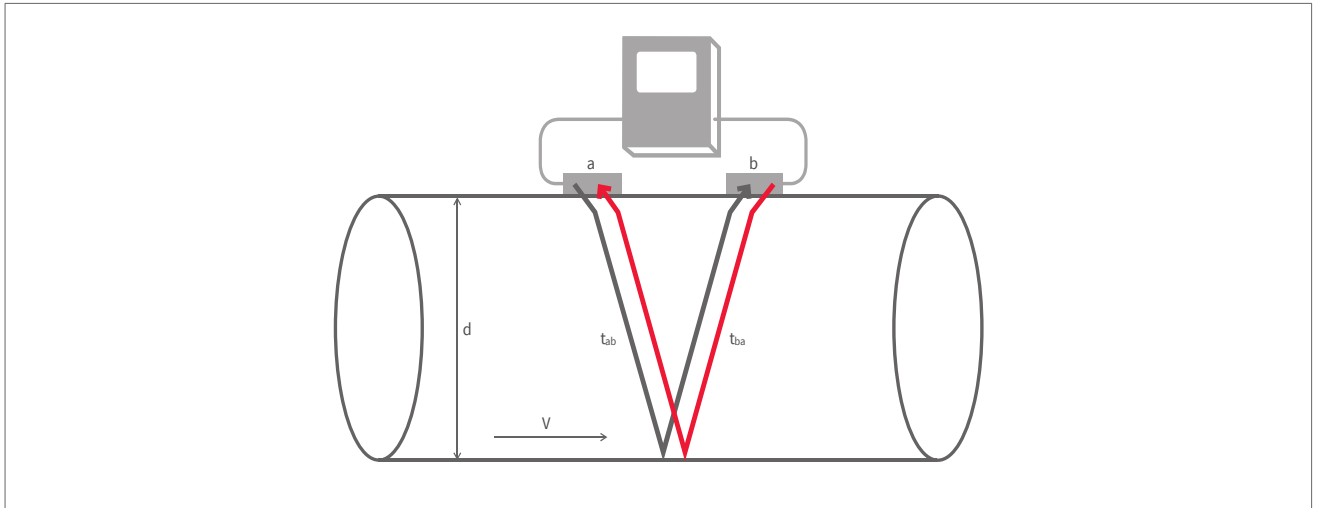

Picture 1: Clamp-on ultrasonic flowmeter configuration

### 2.2 Measuring principle

Ultrasonic signals are emitted by a transducer installed on a pipe and received by a second transducer. These signals are emitted alternately in the direction of flow and against it. Because the medium is flowing, the transit time of the sound signals propagating in the direction of flow is shorter than the transit time of the signal propagating against the direction of flow. The transit-time difference  $\Delta t$  is measured and allows the determination of the average flow velocity along the path of acoustic propagation. A profile correction is then performed to obtain the average flow velocity over the cross-sectional area of the pipe, which is proportional to the volumetric flow rate.

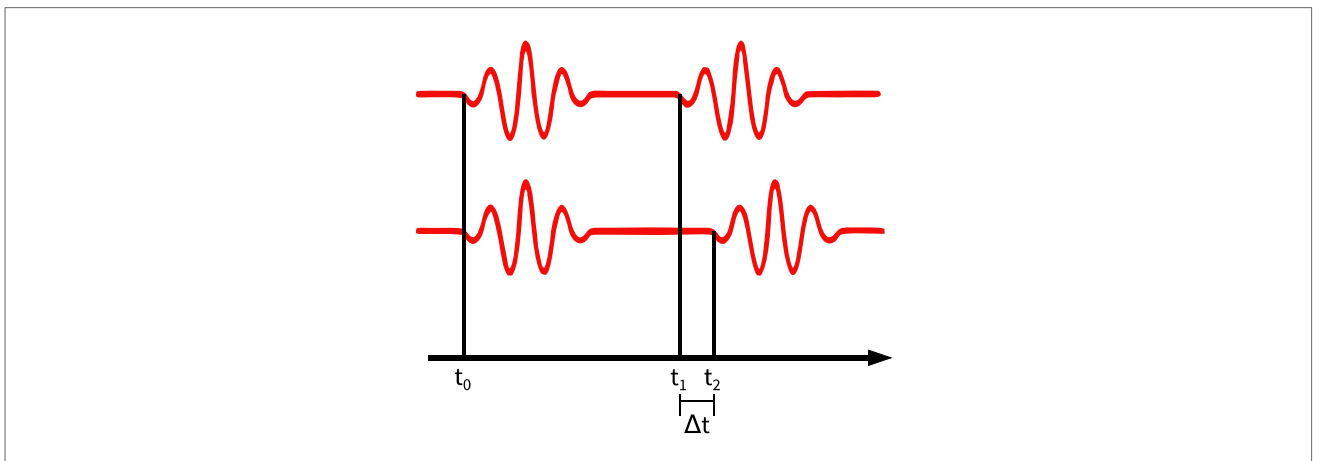

Picture 2: Transit-time measuring principle

# KATflow 230

## INSTALLATION

### 3 INSTALLATION

#### 3.1 Unpacking and storage

##### 3.1.1 Unpacking

Care should be taken when opening the box containing the flowmeter, any markings or warnings shown on the packaging should be observed prior to opening. The following steps should then be taken:

- Unpack the flowmeter in a dry area.
- The flowmeter should be handled with care and not left in an area where it could be subject to physical shocks.
- If using a knife to remove packaging care should be taken not to damage the flowmeter or cables.
- The flowmeter package and contents should be checked against the delivery note supplied and any missing items reported immediately.
- The flowmeter package and contents should be checked for signs of damage during transport and any problems reported immediately.
- The vendor accepts no responsibility for damage or injury caused during the unpacking of the instrumentation supplied.
- Excess packing materials should be either recycled or disposed of in a suitable way.

##### 3.1.2 Storage

If storage is necessary, the flowmeter and sensors should be stored:

- in a secure location,
- away from water and harsh environmental conditions,
- in such a way as to avoid damage,
- small items should be kept together in the bags and small plastic boxes provided to avoid loss.



### 3.1.3 Identification of components

The following items are typically supplied (please refer to your delivery note for a detailed description):

- KATflow 230 portable flowmeter,
- Clamp-on sensors (usually one or two pairs depending on pipe sizes to be measured),
- Sensor extension cable(s) (optional),
- Sensor mounting accessories,
- Coupling component,
- Measuring tape,
- Operating instructions,
- Calibration certificate(s) (optional),
- Temperature measurement probe(s) (optional),
- Wall thickness measurement probe (optional),
- Process output terminal box (optional).

# KATflow 230

## INSTALLATION

### 3.2 System configuration

A maximum of two sensor pairs can be installed. If two pairs are installed these can be configured either in a one-pipe dual-path (see Picture 3) or a two-pipe single-path (see Picture 4) configuration.

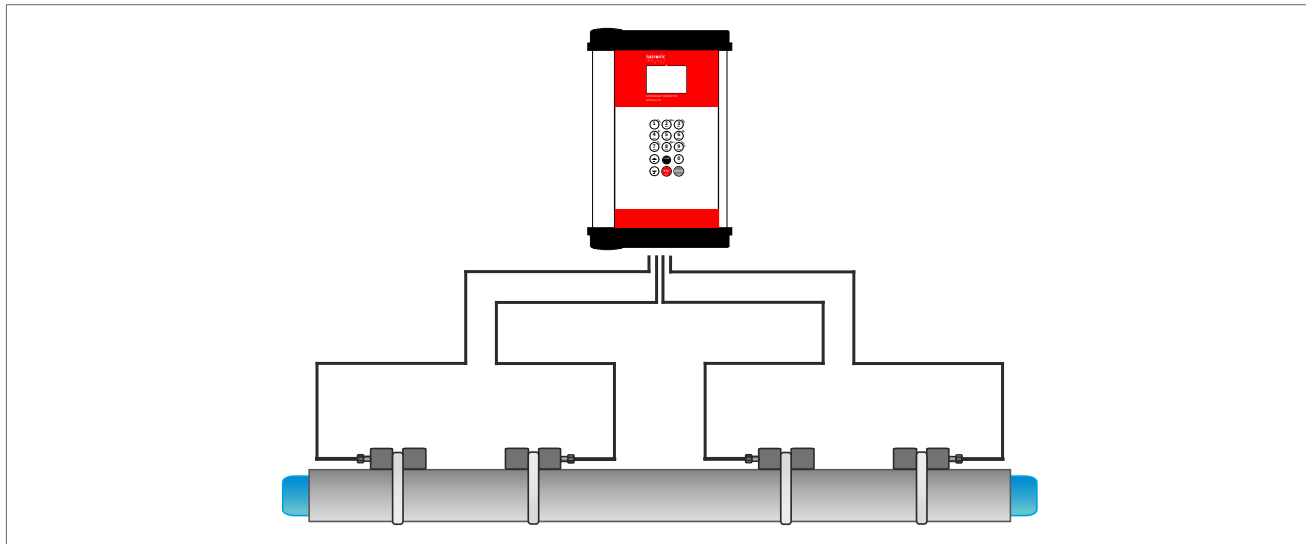

Picture 3: KATflow 230 in a 1-pipe 2-path configuration

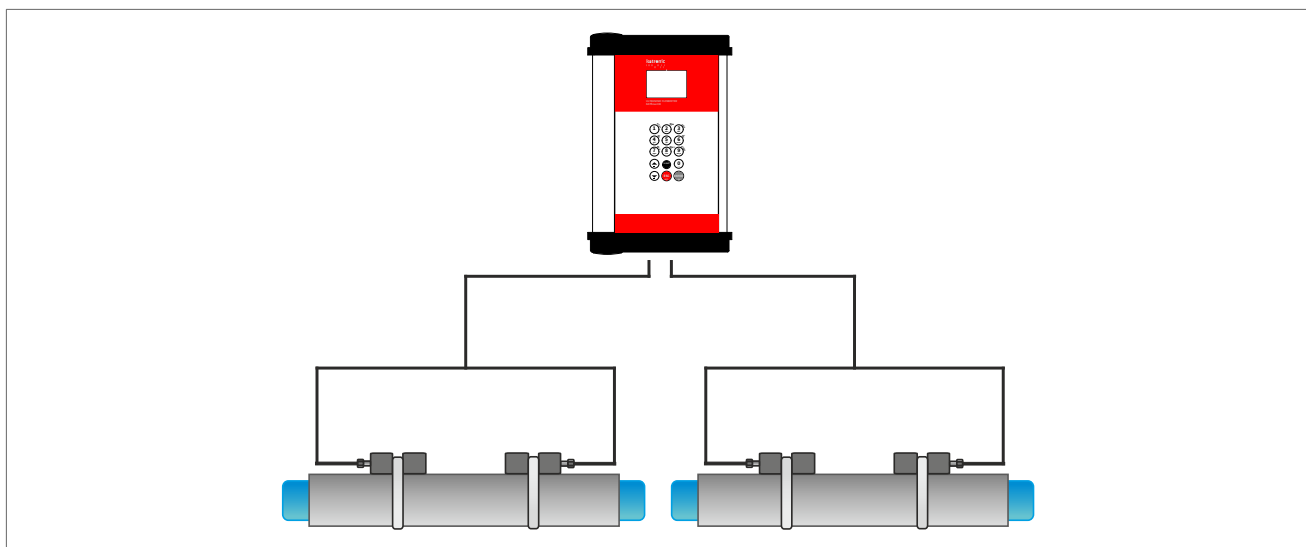

Picture 4: KATflow 230 in a 2-pipe 1-path configuration

### 3.3 Clamp-on sensor installation

The correct selection of the sensor location is crucial for achieving reliable measurements and high accuracy. Measurement must take place on a pipe in which sound can propagate (see Section 3.3.1 Acoustic propagation) and in which a rotationally symmetrical flow profile is fully developed (see Section 3.3.2 Straight pipe lengths).

The correct positioning of the transducers is an essential condition for error-free measurements. It ensures that the sound signal will be received under optimal conditions and evaluated correctly. Because of the variety of applications and the different factors influencing the measurement, there can be no standard solution for the positioning of the transducers.

The correct position of the transducers will be influenced by the following factors:

- diameter, material, lining, wall thickness and general condition of the pipe,
- the medium flowing in the pipe,
- the presence of gas bubbles and solid particles in the medium.



Check that the temperature at the selected location is within the operating temperature range of the transducers (see Chapter 9).

#### 3.3.1 Acoustic propagation

Acoustic propagation is achieved when the flowmeter is able to receive sufficient signal from the transmitted ultrasonic pulses. The signals are attenuated in the pipe material, the medium and at each of the interfaces and reflections. External and internal pipe corrosion, solid particles and gas content in the medium contribute heavily to signal attenuation.

#### 3.3.2 Straight pipe lengths

Sufficient straight lengths of pipe on the inlet and outlet of the measuring location ensure an axi-symmetrical flow profile in the pipe, which is required for good measurement accuracy. If insufficient straight lengths of pipe are available for your application measurements are still obtainable, but the certainty of the measurement can be reduced.

### 3.4 Installation location

Select an installation location following the recommendations in Table 1 and try to avoid measuring:



- in the vicinity of deformations and defects of the pipe,
- near welding seams,
- where deposits could be building up in the pipe.

# KATflow 230

## INSTALLATION

For a horizontal pipe:

Select a location where the transducers can be mounted on the side of the pipe, so that the sound waves emitted by the transducers propagate horizontally in the pipe. In this way, the solid particles deposited on the bottom of the pipe and the gas pockets developing at the top will not influence the propagation of the signal.

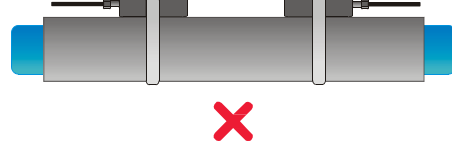
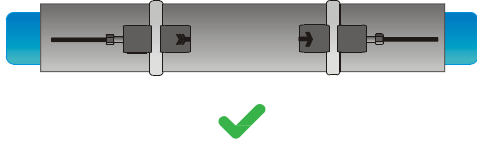

For a free inlet or outlet pipe section:

Select the measuring point at a location where the pipe cannot run empty.

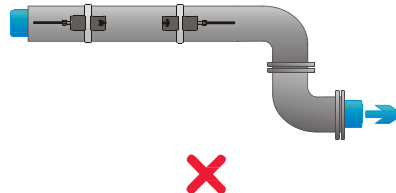
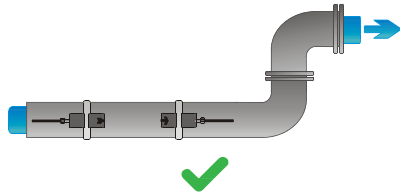
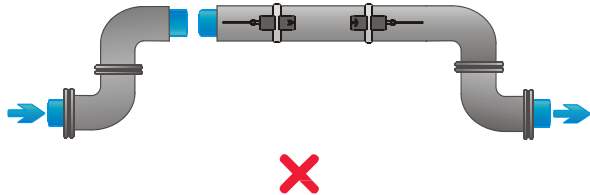
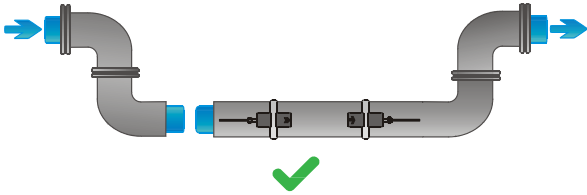

For a vertical pipe:

Select the measuring point at a location where the liquid flows upward to ensure that the pipe is completely filled.

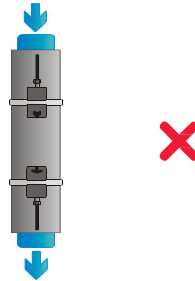
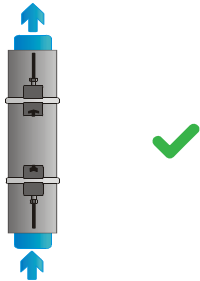
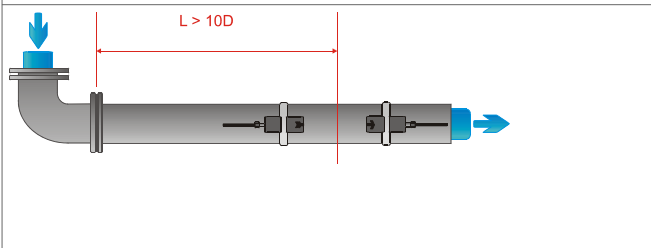
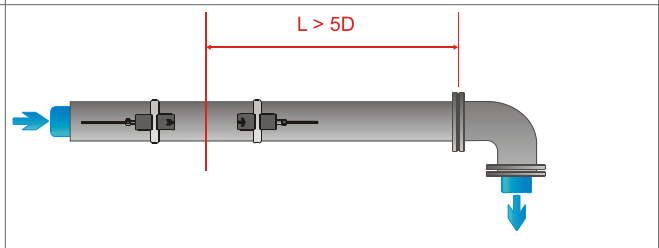
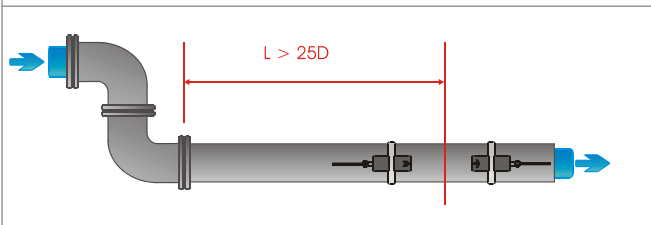
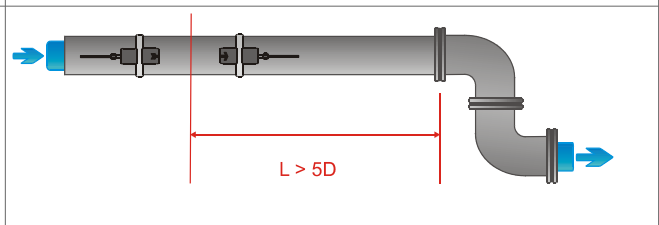
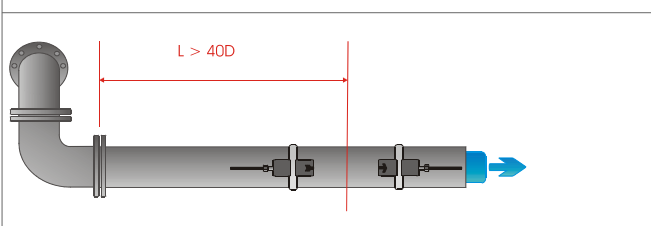
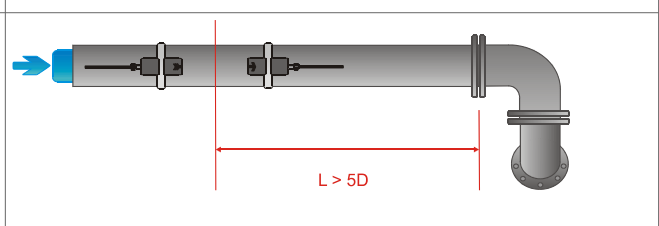
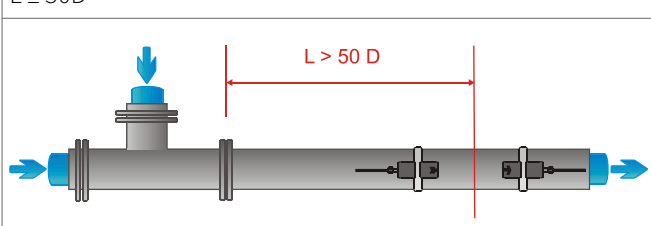
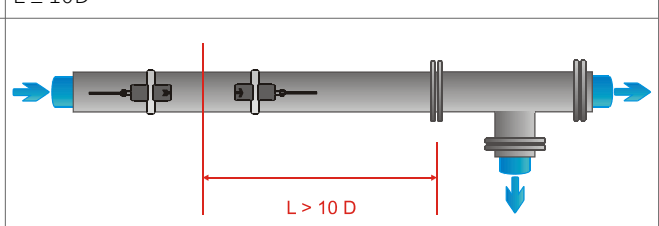
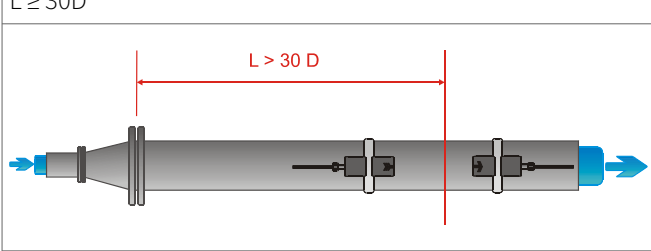
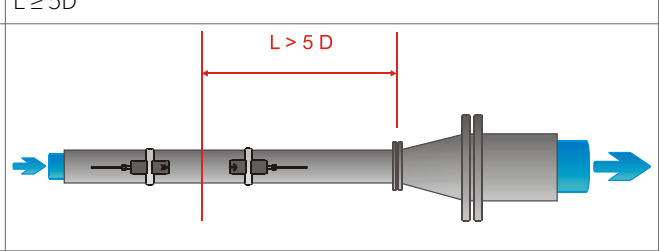

Table 1: Recommendations for sensor mounting location



Look for a sensor installation location with sufficient straight pipe to obtain accurate measurements. Please refer to Table 2 as a guideline for recommended distances from disturbance sources.

<p>Disturbance source: 90°-elbow Inlet <math>L \geq 10D</math></p>	<p>Outlet <math>L \geq 5D</math></p>
	
<p>Disturbance source: 2 x 90°-elbow in one plane Inlet <math>L \geq 25D</math></p>	<p>Outlet <math>L \geq 5D</math></p>
	
<p>Disturbance source: 2 x 90°-elbow in different planes Inlet <math>L \geq 40D</math></p>	<p>Outlet <math>L \geq 5D</math></p>
	
<p>Disturbance source: T-section Inlet <math>L \geq 50D</math></p>	<p>Outlet <math>L \geq 10D</math></p>
	
<p>Disturbance source: diffuser Inlet <math>L \geq 30D</math></p>	<p>Outlet <math>L \geq 5D</math></p>
	

# KATflow 230

## INSTALLATION



Disturbance source: reducer Inlet $L \geq 10D$	Outlet $L \geq 5D$
	
Disturbance source: valve Inlet $L \geq 40D$	Outlet $L \geq 10D$
	
Disturbance source: pump Inlet $L \geq 50D$	
	

Table 2: Recommended distances from disturbance sources

### 3.5 Pipe preparation

- Clean dirt and dust from around the area of the pipework where the sensors are to be placed.
- Remove loose paint and rust with a wire brush or file.
-  Firmly bonded paint does not necessarily need to be removed provided the flowmeter diagnostics indicate sufficient signal strength.

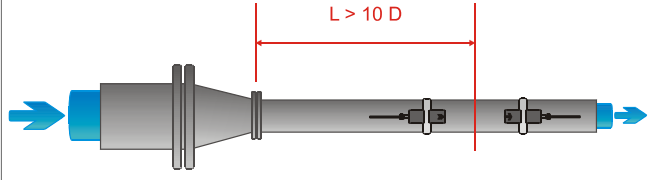
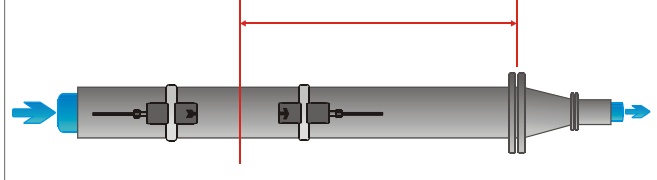
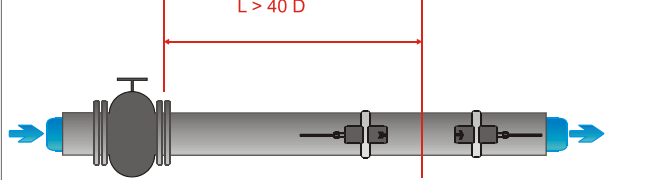
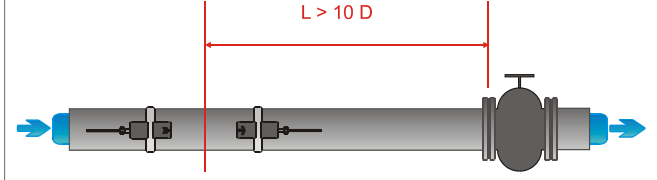
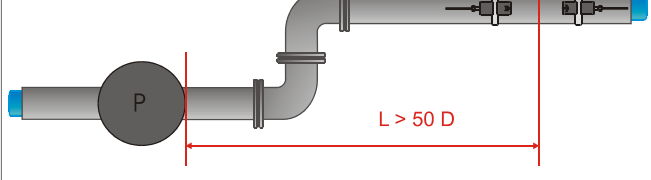
## 3.6 Sensor mounting configurations and separation distance

### 3.6.1 Reflection Mode

The most common clamp-on sensor mounting configuration is the Reflection Mode, sometimes known as V-Mode (see Picture 5, sketch 1). Here, the ultrasonic signal passes twice through the medium (two signal passes). The Reflection Mode is the most convenient mounting method as the transducer separation distance can be measured easily and the sensors can be accurately aligned. This method should be used whenever possible.

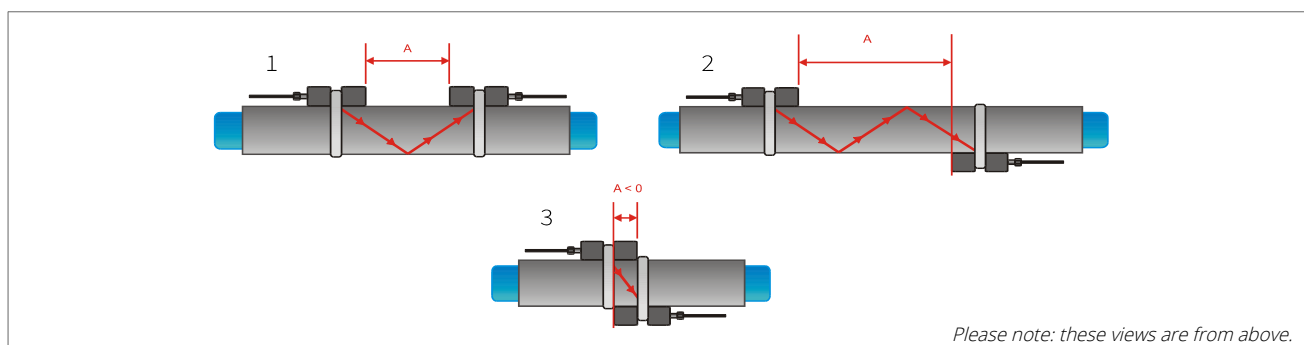

Picture 5: Clamp-on sensor mounting configurations and sensor spacing

### 3.6.2 Diagonal Mode

An alternative mounting configuration (see Picture 5, sketch 3) is the Diagonal Mode (Z-Mode). The signals travel only once through the pipe. This method is often used for larger pipes where greater signal attenuation might occur.

Further variation of the Reflection and the Diagonal Modes are possible by altering the number of passes through the pipe. Any even number of passes will require mounting the sensors on the same side of the pipe, while with an odd number of passes, the sensors must be mounted on opposite sides of the pipe. Commonly, for very small pipes, sensor mounting configurations such as four passes (W-Mode) or three passes (N-Mode) are used (see Picture 5, sketch 2).

### 3.6.3 Transducer separation distance

The transducer separation distance  $A$  is measured from the inside edges of the sensor heads as shown (see Picture 5). It is automatically calculated by the flowmeter based on the parameter entries for pipe outside diameter, wall thickness, lining material and thickness, medium, process temperature, the sensor type and the selected number of signal passes.



A negative separation distance  $A < 0$  can occur for mounting configurations on small pipes where Diagonal Mode operation has been selected (see Picture 5, sketch 3). Negative separation distances may be suggested for Reflection Mode installations, but are not possible. In these cases, use Diagonal Mode or a larger number of passes.

# KATflow 230

## INSTALLATION

### 3.7 Flowmeter installation

#### 3.7.1 Outline dimensions

The KATflow 230 is a portable, battery operated device with the following outline dimensions (Picture 6).

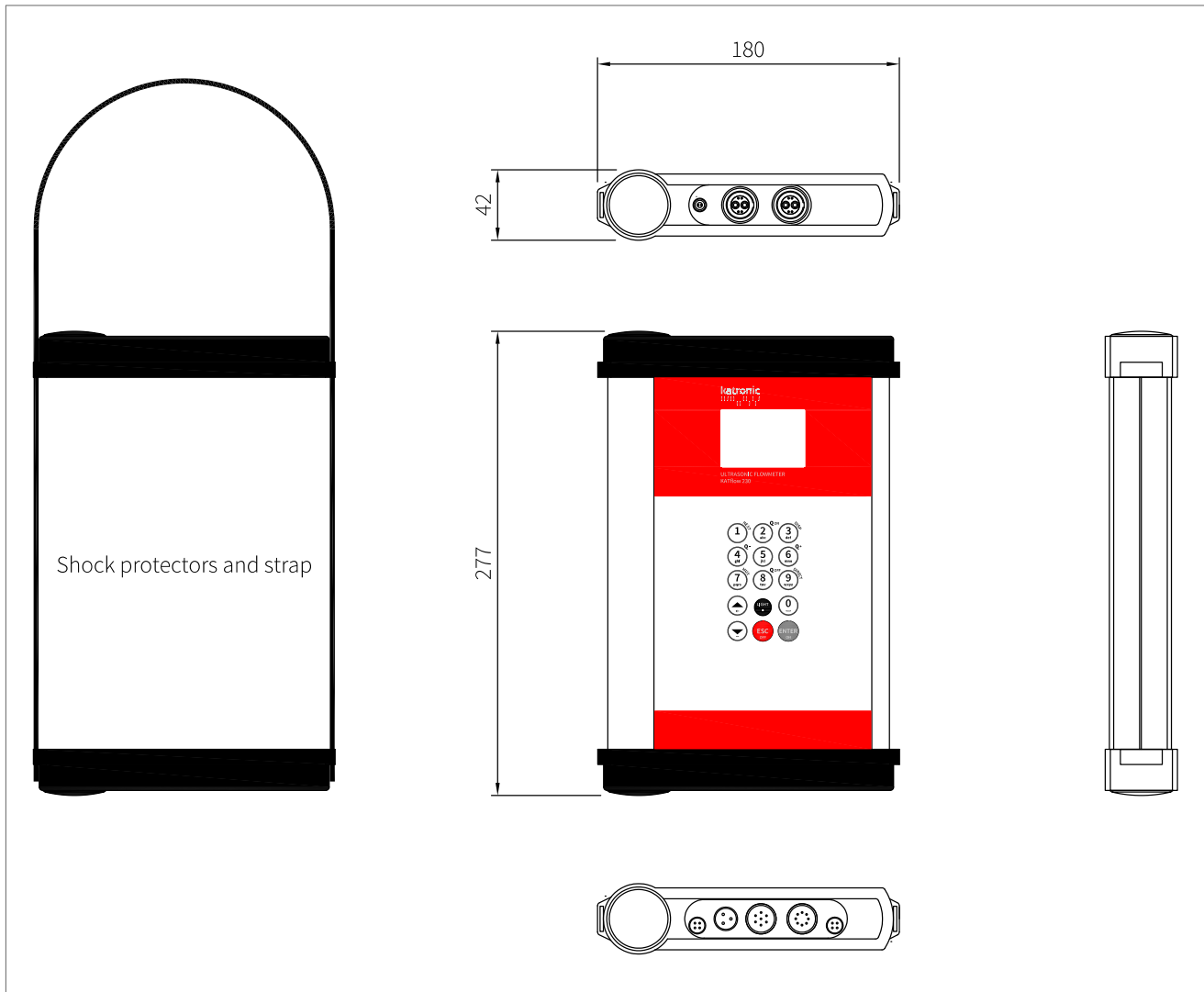

Picture 6: Outline dimensions KATflow 230



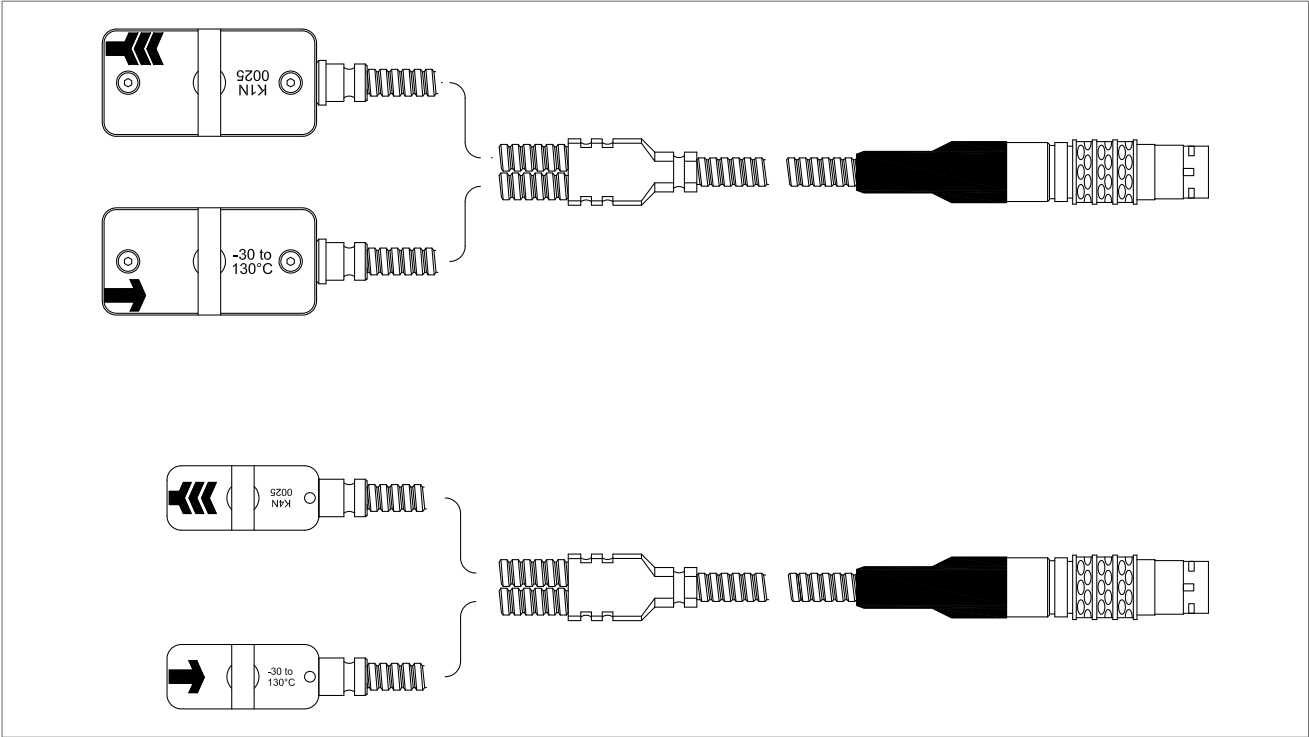

Picture 7: K1 and K4 type transducers

# KATflow 230

## INSTALLATION

### 3.7.2 Electrical connections

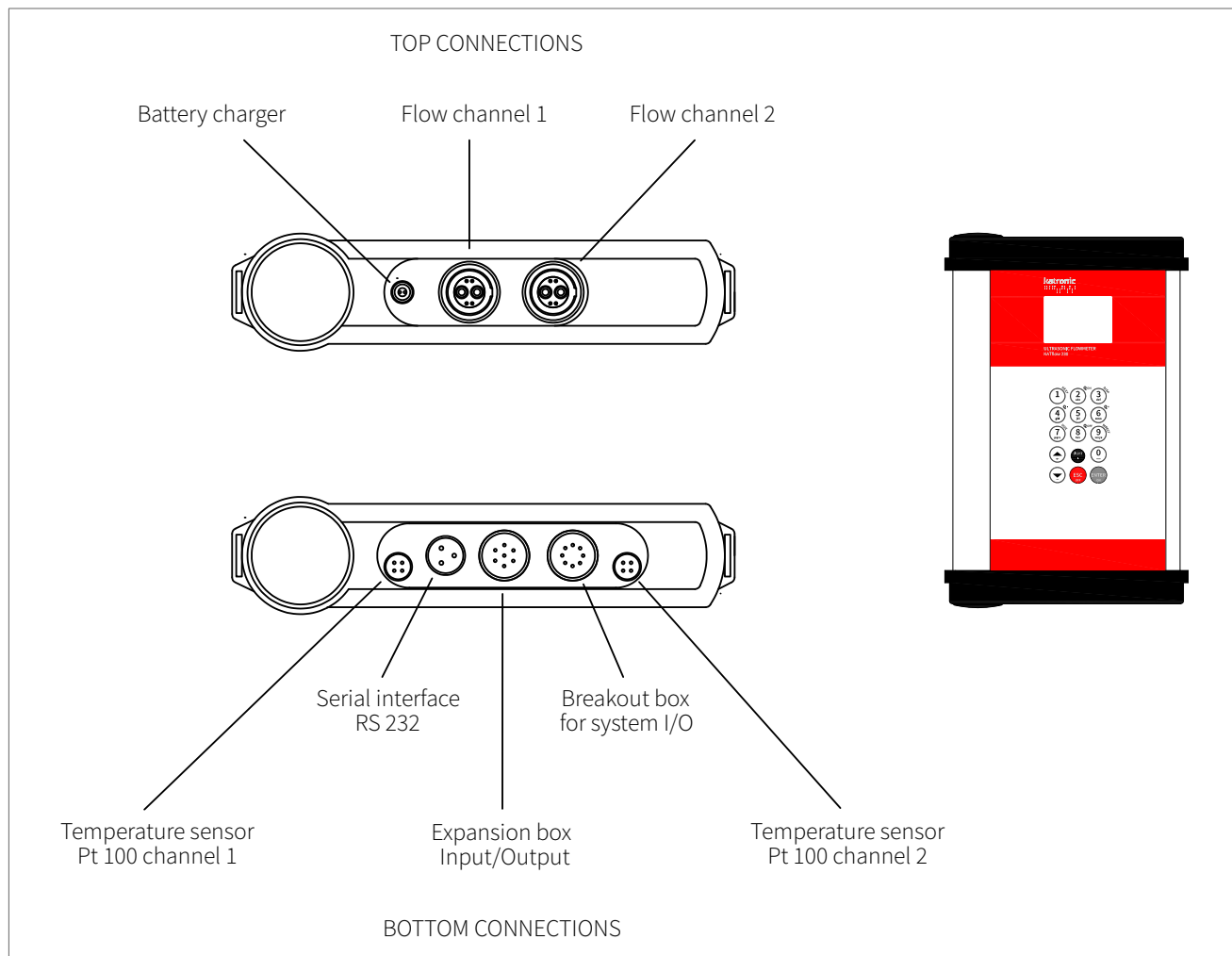

Picture 8: Electrical connection diagram KATflow 230

## 3.8 Clamp-on sensor mounting

Before the sensors can be mounted

- the installation location should have been determined,
- a sensor mounting method should be chosen,
- the flowmeter batteries must be sufficiently charged,
- the sensors must be connected to the transmitter.

Depending on which sensor mounting method is being used, the clamp-on sensors are either mounted on the same side of the pipe (Reflection Mode) or on opposite sides of the pipe (Diagonal Mode). The sensor spacing is calculated by the flowmeter from the pipe parameters entered (see Section 3.6).

### 3.8.1 Acoustic coupling gel



In order to obtain acoustical contact between the pipe and the sensors, apply a bead of acoustic coupling gel lengthwise down the centre of the contact area of the sensors.



Picture 9: Application of acoustic coupling gel

# KATflow 230

## INSTALLATION

### 3.8.2 Correct positioning of the sensors

Always mount the transducer pair so that the free front edges of the sensors face each other. There is a different engraving on the top of each transducer. The transducers are mounted correctly if the engravings on the two transducers form an arrow. The transducer cables should point in opposite directions. Later, the arrow, in conjunction with the indicated measured value, will help to determine the direction of flow (see Section 3.4).



The sensor separation distance is automatically calculated by the flowmeter based on the parameter entries for pipe outside diameter, wall thickness, lining material and thickness, medium, process temperature, the sensor type and the selected number of signal passes. The sensor positioning screen (see Section 4.4) allows fine adjustment of the sensor location.



Picture 10: Correct positioning of the sensors

## 3.8.3 Sensor mounting with fixtures and chains

- Insert the retaining clip into the groove on the top of the transducer and secure it using the screw knob.
- Apply some acoustic coupling component to the contact surface of the transducer.
- Place the transducer on the side of the pipe or alternatively up to 45 degrees from the horizontal plane through the pipe. This is advisable to establish the best acoustic contact since on top of the pipe air pockets could develop and deposits could accumulate at the bottom of the pipe.



- Take the spring end of the chain in one hand and insert the last ball element in the vertical slot of the retaining clip. Mount the chain around the pipe.
- Pull the chain firmly around the pipe and fasten it in the lateral slot of the retaining clip. There should be no air pockets between the transducer surface and the pipe wall.
- Mount the second transducer the same way.
- Using a measuring tape, adjust the sensor separation distance as suggested by the flowmeter. When the sensor positioning screen is displayed, the middle bar allows fine adjustment of the sensor location.



Picture 11: Sensor mounting with clips and chains



Picture 12: Sensor mounting clip

# KATflow 230

## OPERATION

### 4 OPERATION

#### 4.1 Switching On/Off

The flowmeter is switched on by holding the **ON** key for more than two seconds continuously. Equally it can be switched off by pressing the **OFF** key for more than two seconds.

When switching on, the flowmeter will perform a hardware and software check, including the data logger space. Progress will be indicated by a series of dashes above and a black bar below.

#### 4.2 Battery charging

The internal batteries can be recharged with the external battery charger supplied.



Important: Ensure that only Nickel Metal Hydride (NiMH) AA size rechargeable batteries are installed – attempting to recharge other battery types is dangerous and may cause damage.

Connect the battery charger to the charging socket of the flowmeter and to the mains supply 100 ... 240 V AC, 50/60 Hz. The battery charger mains plug is supplied for specific countries as shown in the order code.

The red mark on the plug aligns with the mark on the socket. Remove plug by sliding the outer casing away from the socket to release the latch.

During the charging process, the battery icon will blink. For a fully charged battery all segments of the battery icon will be filled. Battery charge level is also shown in the diagnostic displays.

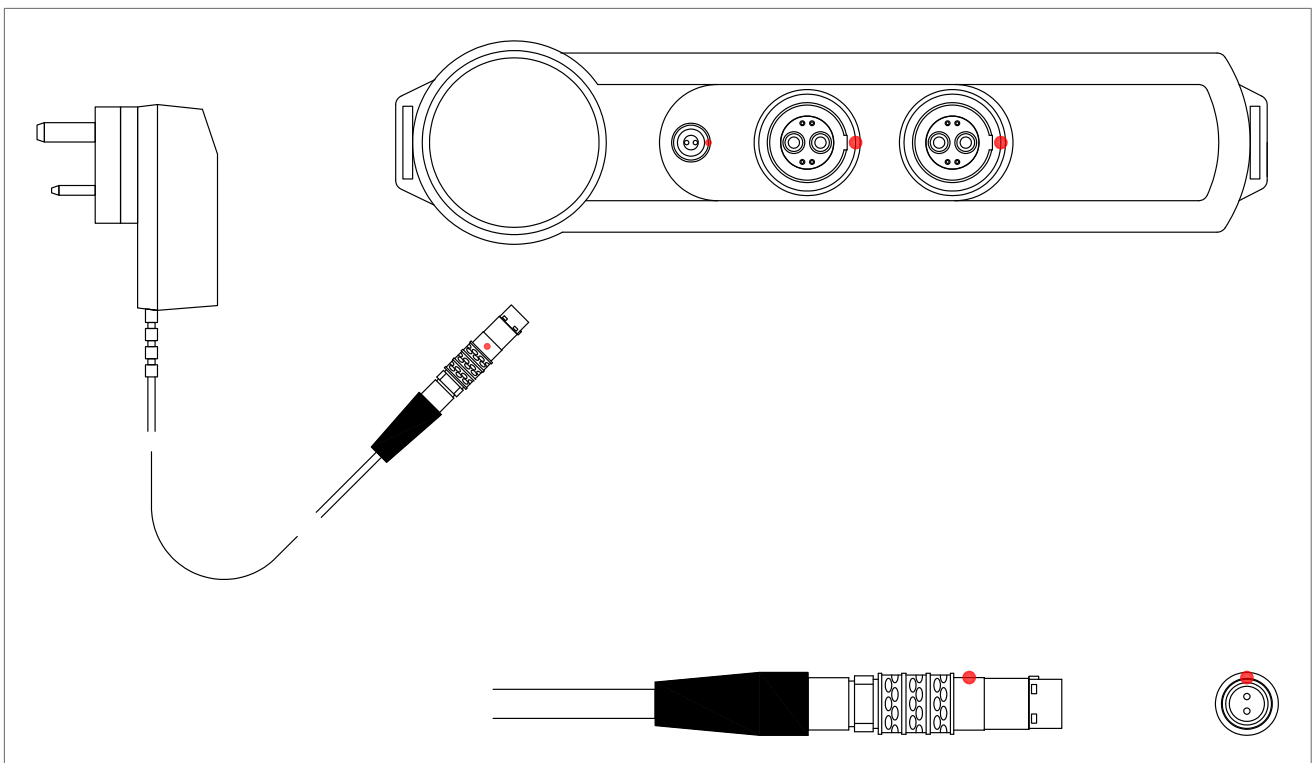

Picture 13: Battery charging

### 4.3 Keypad and display

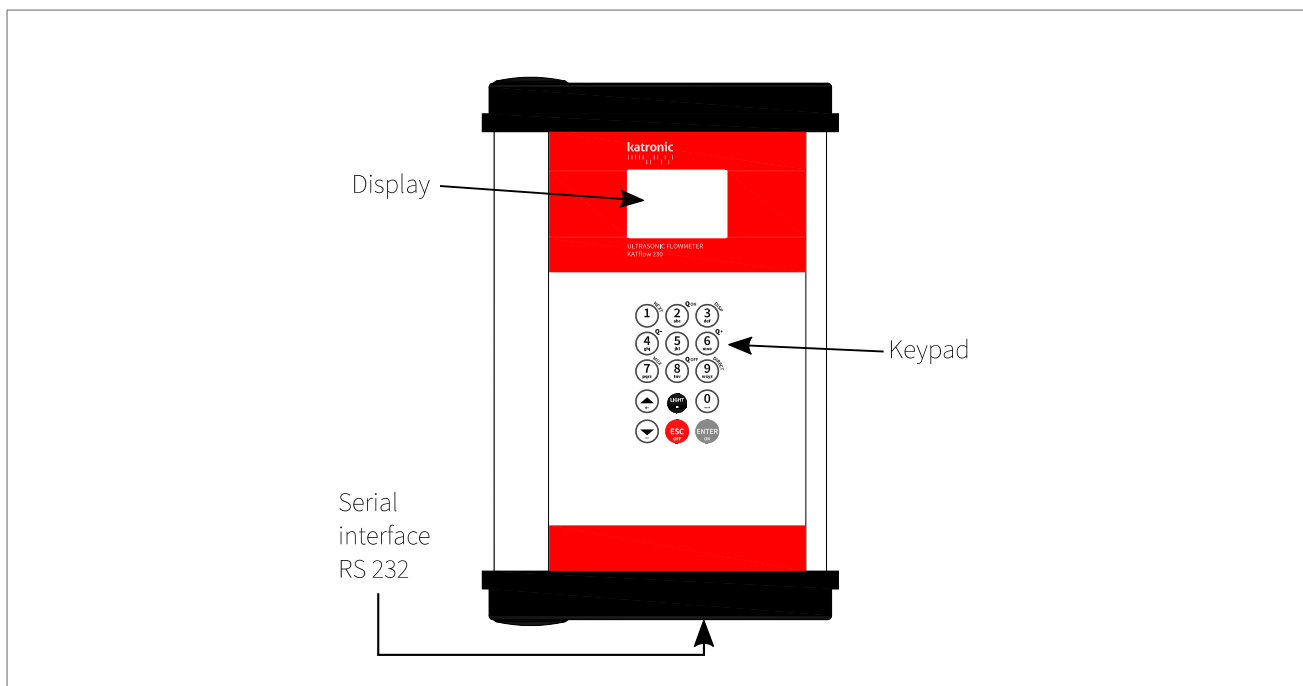

Picture 14: Keypad and display KATflow 230



Customer-specific settings for data to be displayed can be achieved by using the appropriate menu items.

#### 4.3.1 Keypad key functions

Used keys	Main function/Character entry	Secondary function
	1 (1 short key stroke) , (2 short key strokes) . (3 short key strokes) _ (4 short key strokes)	Show <b>NEXT</b> available item
	A B C 2 /	<b>Q<sub>ON</sub></b> = Start/reset totaliser function Adjust screen brightness/contrast (long key stroke)
	D E F 3 ?	Show next <b>DISP</b> lay
	G H I 4 <	<b>Q<sub>-</sub></b> = Reset negative total value

# KATflow 230

## OPERATION











Used keys	Main function/Character entry	Secondary function
	J K L 5 >	-
	M N O 6 \$	Q <sub>+</sub> = Reset positive total value
	P O R S 7	Toggle <b>MULTipleXer</b> (where multi-channel function is provided)
	T U V 8 *	Q <sub>OFF</sub> = Stop totaliser function
	W X Y Z 9	<b>DIRECT</b> access to trend plot
	0 ␣ (Space character) + = #	-
	Move menu/list selection item <b>UP</b>	Character entry: ← (backspace) clear
	Move menu/list selection item <b>DOWN</b>	Character entry: - (minus sign)
	.(decimal point)	Switch LCD backlight on/off
	<b>ESC</b> ape menu item	Abort entry without saving Switches the instrument off if pressed for more than 2 s
	<b>ENTER</b> menu item	Confirm entry with saving Switches the instrument on if pressed for more than 2 s

Table 3: Keypad key functions



4.3.2 Display icons and functions

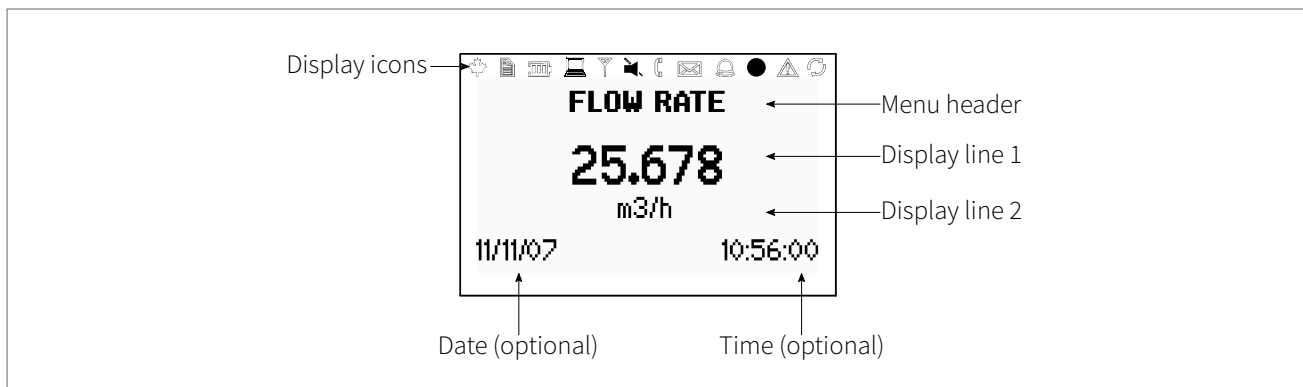

Picture 15: Display overview

Display icon	Function	
		Function not used on KATflow 230
	On Off	Data logger recording Data logger switched off
	On	1 segment = 33 % battery power available
		2 segments = 66 % battery power available
		3 segments = 100 % battery power available
	Off Outline blinking	< 5 % battery power available Battery charging
	On Off	LCD backlight switched on LCD backlight switched off
	On Off	Input and output processor error Input and output processor functioning correctly
	On Off	Speaker on Speaker off
	On Off	Coupling error Sensor operating correctly
		Function not used on KATflow 230
		Function not used on KATflow 230
	On Off	Time/date set Clock error
	On Off	Error recorded in error log No error detected
	On Off	Serial output RS 232 switched on Serial output RS 232 switched off
L, T or LT		Displays whether flow is Laminar, Turbulent or Laminar-Turbulent





Table 4: Display icon functions

# KATflow 230

## OPERATION

### 4.4 Quick Setup Wizard

The Quick Setup Wizard allows for a speedy setup of the most important parameters in order to achieve successful measurements in the shortest possible time:

Used keys	Display screen	Operation
  	<p style="text-align: center;"><b>MAIN MENU</b></p> <pre> Quick start Installation Output System           </pre>	<p>At first power on and the boot sequence, the “Main Menu” is displayed. Use the <b>UP ▲</b> and <b>DOWN ▼</b> cursor keys to select “Quick Start” and confirm by pressing <b>ENTER</b>.</p>
	<p style="text-align: center;"><b>QUICK START</b></p> <pre> Setup Wizard CH1 Setup Wizard CH2 Stored Setup Start Measurement           </pre>	<p>Use cursor keys to select “Setup Wizard”. Confirm by pressing <b>ENTER</b>. If the sensors are recognised, the serial number will be shown. If not, the type can be selected.</p>
	<p style="text-align: center;"><b>MIDDLE UNITS</b></p> <pre> m3/h m3/m m3/s           </pre>	<p>Select the main measurement unit using the cursor keys and confirm with <b>ENTER</b>. This unit will be displayed in the middle of the measurement screen. Selecting <b>OFF</b> deactivates the measurement channel.</p>
	<p style="text-align: center;"><b>PIPE MATERIAL</b></p> <pre> Stainless Steel Carbon Steel Ductile cast iron           </pre>	<p>Select pipe material using the cursor keys and confirm with <b>ENTER</b>.</p>
	<p style="text-align: center;"><b>OUTSIDE DIAMETER</b></p> <p style="text-align: center;"><b>76.1</b> mm</p>	<p>Enter the outer pipe diameter using the alphanumeric keys and confirm with <b>ENTER</b>. Use <b>UP ▲</b> key as backspace to correct for entry errors. If 0 is entered and confirmed, an additional screen appears that allows entry of the circumference.</p>
	<p style="text-align: center;"><b>CIRC</b></p> <p style="text-align: center;"><b>103.0</b> mm</p>	<p>Enter the circumference using the alphanumeric keys. Press <b>ENTER</b> to confirm.</p>
	<p style="text-align: center;"><b>WALL THICKNESS</b></p> <p style="text-align: center;"><b>3.4</b> mm</p>	<p>Enter pipe wall thickness using the alphanumeric keys and confirm with <b>ENTER</b>. Use <b>UP ▲</b> key as a backspace to correct for entry errors.</p>



Used keys	Display screen	Operation
	<p><b>INNER DIAMETER</b></p> <p><b>69.3</b> mm</p>	<p>Enter the inner pipe diameter using the alphanumeric keys and confirm by pressing <b>ENTER</b>.</p> <p>The value that appears here will have been calculated from the entered outside diameter (or circumference) and wall thickness. Entering a new value will recalculate the outside diameter.</p>
	<p><b>FLUID</b></p> <p>Water Saltwater Acetone</p>	<p>Select the fluid using cursor keys. Confirm by pressing <b>ENTER</b>.</p>
	<p><b>TEMPERATURE</b></p> <p><b>20.0</b> C</p>	<p>Enter the fluid temperature using the keypad. Confirm by pressing <b>ENTER</b>. Use <b>UP ▲</b> key as a backspace to correct for entry errors.</p>
	<p><b>LINER MATERIAL</b></p> <p>None Epoxy Rubber</p>	<p>Select pipe liner material using cursor keys and confirm by pressing <b>ENTER</b>.</p> <p>If a liner material is chosen, an additional screen appears that allows entry of liner thickness.</p>
	<p><b>PASSES</b></p> <p>Auto 1 2</p>	<p>Select number of sound passes (sound paths) using cursor keys.</p> <p>Auto: Automatically 1: 1 pass (Diagonal Mode) 2: 2 passes (Reflection Mode) 3: 3 passes (Diagonal Mode) 4: 4 passes (Reflection Mode) etc.</p> <p>Confirm with <b>ENTER</b>.</p>
	<p><b>QUICK START</b></p> <p>Setup Wizard CH2 Stored Setup Start Measurement Scope</p>	<p>Select "Start Measurement" and confirm with <b>ENTER</b> to start the sensor positioning procedure.</p>
	<p><b>CHNL1 SENSOR</b></p> <p>Spacing 110.5 mm Using 2 passes Signal 26 dB</p> 	<p>Sensor positioning screen: Mount transducers with suggested spacing and use middle bar for fine adjustment of position (central position is desired). Observe signal-to-noise (upper bar) and quality (lower bar). These should be of identical length. Confirm by pressing <b>ENTER</b> to obtain measurements.</p> <p>Note: Numbers shown are for indication only.</p>
	<p><b>CHNL-1</b></p> <p><b>25.678</b> m3/h</p> <p>11/11/07 10:56:00</p>	<p>Success!</p>

Table 5: Quick Setup Wizard

# KATflow 230

## OPERATION

### 4.5 Measurement

#### 4.5.1 Main process value display

Measurement is started using “Start Measurement” in the Quick Start Wizard. If all parameters have been entered, the next time the flowmeter is switched on the main process value (PV) is immediately shown on the display and/or made available as an output signal (if installed and operating).



The main process value (PV) is the primary measurement data and is usually displayed as the middle unit. User-specific settings for the main process value display can be made using the corresponding options in the menu. The process value can be selected from a list of available values.

Used keys	Display screen	Operation
		<p>The main process value can be changed in the “Quick Start” or “Installation” menus. Press <b>ESC</b> at any time to return to the “Main Menu”. View totalisers by pressing <b>NEXT</b>. Change to the diagnostic display by pressing <b>DISP</b>.</p>

Table 6: Main process value display

#### 4.5.2 Three-line display

Used keys	Display screen	Operation
		<p>The three-line display screen is configurable to show flow, totalisers and diagnostic functions. Change to diagnostic displays by pressing <b>DISP</b> and to totaliser screens by pressing <b>DISP</b> and to totaliser screens by pressing <b>NEXT</b>. Cycle through display screens using <b>NEXT</b>. Cycle through available flow channels using <b>MUX</b>.</p>

Table 7: Main process value display in three-line display format

#### 4.5.3 Diagnostic display

Used keys	Display screen	Operation
	<p style="text-align: center;"><b>DIAGNOSTIC 1</b></p> <p style="text-align: center;">55.2 Gain <b>20.5 Signal</b> -10.0 Noise</p> <p>11/11/07 <span style="float: right;">10:56:00</span></p>	<p>Line 1 shows the amplifier gain. Line 2 displays the signal strength. Line 3 indicates the noise. Change to more diagnostic displays by pressing NEXT. Refer to Customer Support for the meanings of each diagnostic screen.</p>

Table 8: Diagnostic display



Diagnostic displays can be viewed directly during measurement. Other diagnostic functions are available in the menu structure.

#### 4.5.4 Totaliser



The totaliser displays will only be shown when the totalisers are activated.







Used keys	Display screen	Operation
 	<p style="text-align: center;"><b>CHNL-1</b></p> <p style="text-align: center;">- 1.3 m3 <b>25.678 m3/h</b> 37.3 m3</p> <p>11/11/07 <span style="float: right;">10:56:00</span></p>	<p>The flow totaliser can be started or reset by pressing Q<sub>ON</sub> when a volume measurement is selected as one of the displayed units. Totaliser screens are viewed by pressing NEXT from the measurement screen. When top and bottom display lines are set to a volume measurement, the first totaliser screen displays cumulative totals and the second screen shows separate positive and negative totals. Pressing NEXT again will return to the main measurement screen.</p>
 		<p>Pressing Q<sub>+</sub> resets the total accumulated flow in the positive flow direction. Pressing Q<sub>-</sub> resets the total accumulated flow in the negative flow direction.</p>
		<p>The totalisers can be stopped by pressing Q<sub>OFF</sub>.</p>
 		<p>Pressing Q<sub>ON</sub> again will reset to zero. Change to other displays or revert to the totaliser screen without resetting by pressing DISP or NEXT.</p>

Table 9: Totaliser display

# KATflow 230

## OPERATION

### 4.5.5 Dual-channel measurement screen

Used keys	Display screen	Operation
	<pre> DUAL-1  37.3 m3/h  1.370 11/11/07           10:56:00           </pre>	<p>Line 1 shows the PV on the selected channel.            Line 2 shows the selected units.            Line 3 shows the PV on the other channel (in its selected units)</p> <p>Change to diagnostic displays by pressing <b>DISP</b> and to totaliser and main PV screens by pressing <b>NEXT</b>.            Cycle through available flow channels using <b>MUX</b>.</p>

Table 10: Dual-channel measurement screen

### 4.5.6 “Math” display

Used keys	Display screen	Operation
	<pre> MATH-1 27.678 AVE m3/h 11/11/07           10:56:00           </pre>	<p>Displays the “Math” function (when enabled on multi-channel meters).            “Sum”, “Difference”, “Average” and “Maximum” can be selected in the “Calculation” menu.            “Average” shown in illustration.</p> <p>Change to diagnostic displays by pressing <b>DISP</b> and to totaliser, dual and main PV screens by pressing <b>NEXT</b>.</p>

Table 11: “Math” display

### 4.5.7 Data logger

- The data logger is enabled from the “Main Menu” and operates when a non-zero value is entered for the interval.
- Items to be logged are selected from the “Selection” screen. **ENTER** selects items, **0** deselects.
- Up to ten items may be selected.
- If no items are selected the logger will record blank space.
- Send logger by serial port to a terminal program by selecting “Log Download”.
- Clear the logger by selecting “Log Erase”.
- Remaining logger space can be seen in the diagnostic displays.
- Logged data can be downloaded, viewed and exported using the KATdata+ software except when “Wrap Mode” has been enabled.



## 5 COMMISSIONING

### 5.1 Menu structure

Main menu	Menu level 1	Menu level 2	Description/settings
Quick Start			
	Setup Wizard CH1 or CH2		Select channel 1, channel 2
		Default sensor	Indication of sensor type and serial number if automatically detected, otherwise select from list ↕ <ul style="list-style-type: none"> <li>• K1N, K1L, K1E, K1Ex, K1P</li> <li>• K4N, K4L, K4E, K4Ex, K4P</li> <li>• K0, M, Q, Special</li> </ul>
		Middle units (main displayed)	Select from list where available ↕ <ul style="list-style-type: none"> <li>• m/s, ft/s, in/s, m<sup>3</sup>/h, m<sup>3</sup>/min, m<sup>3</sup>/s, l/h, l/min, l/s</li> <li>• USgal/h, USgal/min, USgal/s, bbl/d, bl/h, bbl/min</li> <li>• g/s, t/h, kg/h, kg/min, m<sup>3</sup>, l, USgal, bbl, g, t, kg</li> <li>• W, kW, MW, J, kJ, MJ</li> <li>• Signal dB, noise dB, SNR (dB)</li> <li>• C m/s (speed of sound), CU (housing temperature)</li> <li>• K (correction factor), REY (Reynolds number)</li> <li>• SOS, DEN, KIN, SHC (sound speed, density, kinematic viscosity, specific heat capacity from inputs/calculation)</li> <li>• TEMP (specified or measured fluid temperature)</li> <li>• PRESS (specified or measured fluid pressure)</li> <li>• T<sub>in</sub>, T<sub>out</sub> (inlet and outlet temperature)</li> <li>• Other (assignable input or calculated value)</li> <li>• Math (calculated value – see below)</li> </ul>
		Pipe material	Select from list ↕ <ul style="list-style-type: none"> <li>• Stainless steel, Carbon steel, Ductile cast iron, Grey cast iron, Copper, Lead, PVC, PP, PE, ABS, Glass, Cement</li> <li>• User (pipe speed of sound)</li> </ul>
		Pipe c-speed	(Only if user pipe material selected) 500 ... 5 000 m/s
		Outside diameter	6 ... 6 500 mm
		Wall thickness	0.5 ... 75 mm
		Inner diameter	6 ... 6 500 mm
		Fluid	Select from list ↕ <ul style="list-style-type: none"> <li>• Water, Salt water, Acetone, Alcohol, Ammonia Carbon Tet (carbon tetrachloride), Ethanol, Ethyl alcohol, Ethyl ether, Ethylene glycol, Glycol/water 50 %, Kerosene, Methanol, Methyl alcohol, Milk, Naphtha, Car oil, Refrigerant R134a, Refrigerant R22, Hydrochloric acid, Sour cream, Sulphuric acid, Toluene, Vinyl chloride</li> <li>• User (kinematic viscosity, density, medium c-speed)</li> </ul>
		Kinematic viscosity	(Only if user fluid selected) 0 ... 30 000 mm <sup>2</sup> /s
		Density	(Only if user fluid selected) 100 ... 2 000 kg/m <sup>3</sup>

# KATflow 230

## COMMISSIONING

Main menu	Menu level 1	Menu level 2	Description/settings
		Medium c-speed	(Only if user fluid selected) 800 ... 3 500 m/s
		Temperature	-30 ... +300 °C
		Liner material	Select from list ↑↓ <ul style="list-style-type: none"> <li>• None</li> <li>• Epoxy, Rubber, PVDF, PP, Glass, Cement</li> <li>• User (liner c-speed )</li> </ul>
		Liner thickness	(Only if lining material selected) 1.0 ... 99.0 mm
		Liner c-speed	(Only if lining material selected) 500 ... 5 000 m/s
		Passes	Select from list ↑↓ Auto, 1 ... 16
	WTG Wizard		
			Reference Thickness (THK)
			Calibrate
	Stored setup		“Load”, “Save” or “Delete” stored sets of parameters (Names for different measurement points can be entered on “Save” using the keypad)
	Start measurement		
		Sensor type	Indication of sensor type and serial number if automatically detected, otherwise select from list ↑↓
		SP1 – Sensor frequency	Only for special, unrecognised sensors
		SP2 – Wedge angle	Only for special, unrecognised sensors
		SP3 – Wedge c-speed 1	Only for special, unrecognised sensors
		SP4 – Wedge c-speed 2	Only for special, unrecognised sensors
		SP5 – Crystal offset	Only for special, unrecognised sensors
		SP6 – Spacing offset	Only for special, unrecognised sensors
		SP7 – Zero flow offset	Only for special, unrecognised sensors
		SP8 – Upstream offset	Only for special, unrecognised sensors
		Sensor K factor	Only for special, unrecognised sensors
	Scope		Shows the received acoustic pulse and further data to evaluate the signal quality as an oscilloscope function on channel 1 only (see Section 5.11)
Installation			Select channel 1, channel 2



Main menu	Menu level 1	Menu level 2	Description/settings
	Pipe		
		Material	Select from pipe material list ↑↓
		Outside dia	6 ... 6 500 mm (outside diameter)
		Wall thk	0.5 ... 75 mm (wall thickness)
		Inner dia	6 ... 6 500 mm (inner diameter)
		C-speed	600 ... 6 554 m/s (transverse sound speed pipe)
		L-speed	600 ... 8 000 m/s (longitudinal sound speed pipe)
		Circumfer	18.8 ... 20 420 mm (pipe circumference)
		Roughness	0 ... 10 mm
	Medium		
		Fluid	Select from fluid list ↑↓
		Kinematic viscosity	0 ... 30 000 mm <sup>2</sup> /s
		Dynamic viscosity	0 ... 60 kg s <sup>-1</sup> m <sup>-1</sup>
		Density	100 ... 2 000 kg/m <sup>3</sup>
		C-speed	800 ... 3 500 m/s
		Temperature	-30 ... +300 °C
	Lining		
		Material	Select from material list ↑↓
		Thickness	0.1 ... 99.9 mm
		C-speed	500 ... 6 553 m/s
	Passes		Select from list ↑↓
Display			Select channel 1, channel 2
		Top line	Select unit from list ↑↓
		Middle line	Select unit from list ↑↓
		Bottom line	Select unit from list ↑↓
		Damping	Reduces fluctuations in the display output: 1 ... 255 s
		Metric/Imp.	Use metric or imperial units for entered data
		Auto Seq. Timer	Set automatic change of display
In/Output			Lists available input/output slots Possible configurable settings below [where specified]
	I Out		Analogue current output (active or passive)
		Source	Select from list ↑↓ Off, Channel 1, Channel 2, Math 1, Math 2, System, Test
		Units	Select from list ↑↓
		Min. value	Min. process variable (PV) value that corresponds to 0 mA (only active) or 4 mA
		Max. value	Max. process variable (PV) value that corresponds to 20 mA

# KATflow 230

## COMMISSIONING

Main menu	Menu level 1	Menu level 2	Description/settings
		Damping	Additional smoothing of the current output, the higher the damping factor: 1 ... 255 s
		Span	0 ... 20 mA (only active) or 4 ... 20 mA
		Error	Defines output behaviour in the event of error Select from list ↑↓ <ul style="list-style-type: none"> <li>• Hold (hold last value, select hold time)</li> <li>• 3.8 mA</li> <li>• 21.0 mA</li> </ul>
	Voltage Out		Analogue voltage output
		Source	Select from list ↑↓ Off, Channel 1, Channel 2, Math 1, Math 2, System, Test
		Units	Select from list ↑↓
		Min. value	Min. process variable (PV) value that corresponds to 0 V
		Max. value	Max. process variable (PV) value that corresponds to 10 V
		Damping	Additional smoothing of the current output, the higher the damping factor: 1 ... 255 s
	Frequency Out		Analogue frequency output
		Source	Select from list ↑↓ Off, Channel 1, Channel 2, Math 1, Math 2, System, Test
		Units	Select from list ↑↓
		Min. value	Min. process variable (PV) value that corresponds to minimum frequency
		Max. value	Max. process variable (PV) value that corresponds to maximum frequency
		Damping	Additional smoothing of the current output, the higher the damping factor: 1 ... 255 s
	Pulse Out		Digital open-collector output
		Source	Select from list ↑↓ Off, Channel 1, Channel 2, Math 1, Math 2, System, Test
		Units	Select from list ↑↓

Main menu	Menu level 1	Menu level 2	Description/settings
		Mode	<p>Select from list ↑↓</p> <p>Alarm: PV alarm switch</p> <ul style="list-style-type: none"> <li>On point – Value of the process variable (PV) at which the relay switches to alarm mode</li> <li>Off point – Value of the process variable (PV) at which the relay interrupts the alarm mode again</li> </ul> <p>Pulse: Sum value of the selected process variable (PV) for which a pulse signal is generated, e. g. PV [m<sup>3</sup>/h], pulse value = 10, a pulse is generated every 10 m<sup>3</sup></p> <ul style="list-style-type: none"> <li>Value: 0.01 ... 1 000</li> <li>Width: Duration of the pulse 30 ... 999 ms</li> <li>Source (Grand, Positive, Negative)</li> </ul> <p>Linear: Calculated maximum number of pulses per second, i. e. the maximum pulse rate in Hz</p> <ul style="list-style-type: none"> <li>Min. value</li> <li>Max. value</li> <li>Damping (in s)</li> </ul>
	Relay Out		Digital relay output
		Source	<p>Select from list</p> <p>↑↓ Off, Channel 1, Channel 2, Math 1, Math 2, System, Test</p>
		Units	Select from list ↑↓
		Mode	<p>Select from list ↑↓</p> <p>Alarm:</p> <ul style="list-style-type: none"> <li>On point – Value of the process variable (PV) at which the relay switches to alarm mode</li> <li>Off point – Value of the process variable (PV) at which the relay interrupts the alarm mode again</li> </ul> <p>Pulse:</p> <ul style="list-style-type: none"> <li>Value</li> <li>Width</li> </ul> <p>Linear:</p> <ul style="list-style-type: none"> <li>Min. value</li> <li>Max. value</li> <li>Damping</li> </ul>
	Pt 100 4 Wire		Temperature input
		Source	<p>Select from list</p> <p>↑↓ Off, Channel 1, Channel 2, Math 1, Math 2, System, Test</p>
		Type	<p>Select from list ↑↓</p> <ul style="list-style-type: none"> <li>User – Input of a temperature value defined by the user within the range 0 ... +250 °C</li> <li>Pt 100 – Temperature (in °C) determined and read in by a probe (Pt 100)</li> </ul>
		In-Out	<p>Select from list ↑↓</p> <ul style="list-style-type: none"> <li>Inlet – Input of a fixed temperature value for the inlet within the range 0 ... +250 °C</li> <li>Outlet – Input of a fixed temperature value for the outlet within the range 0 ... +250 °C</li> <li>Comp. – Input of a user-defined offset within the range -100 ... +100 °C</li> </ul>
	Current In		Analogue current input (passive or active)

# KATflow 230

## COMMISSIONING

Main menu	Menu level 1	Menu level 2	Description/settings
		Source (channel)	Select from list ↑↓ Off, Channel 1, Channel 2, Math 1, Math 2, System, Test
		Source (value)	Select from list ↑↓ Density, Viscosity, Temperature, Pressure, Other
		Min. value	Minimum as on outputs
		Max. value	Maximum as on outputs
		Span	0 ... 20 mA or 4 ... 20 mA
	RS 485		[where specified]
	Modbus TCP		Enter address
	HART		[HART® compatible output, where specified]
	Other In/Out types		Refer to Technical Support
System			
	Instrument info		
		Model code	KATflow 230
		Serial number	Example: 230002633
		HW revision	Example: 3.00, 1.70
		SW revision	Example: 4.22-7565, 4.00
	Calculation		
		Select channel	Select channel 1, channel 2
		Low flow cut off	± Low flow velocity cut off: 0 ... 0.10 m/s
		Max. flow cut off	± Maximum flow velocity cut off: 0 ... 30 m/s
		Corrected	Apply flow velocity profile correction: Yes/No
		PV offset	Calibration process variable zero offset: -30 ... +30 units
		PV scaling	Calibration process variable gradient scaling: 0 ... 1 000 units
		Zero calibration	Zero calibration settings Adjust: <ul style="list-style-type: none"> <li>Zero (Yes/No): Sets current flow as zero (Perform auto zero calibration)</li> <li>Track (Yes/No): Zero follows output variations</li> <li>Delta time: Zero flow offset in ns (Zero flow delta time offset in ns, read from sensor PROM or entered directly for special sensors)</li> <li>Time up: Transit time offset in µs, for delays in special sensors, thermal buffers and cable extensions</li> </ul>
		Math function	Select from list ↑↓ None, Sum, Difference, Average (mean), Maximum
		Heat capacity	Specify heat capacity of the medium
	User		
		Identifier	Example: Pump P3A (9 character string possible)
		Tag No	Tag Number: Example: 1FT-3011 (9 character string possible)
		Password	Set 4 character password (default 1111)

Main menu	Menu level 1	Menu level 2	Description/settings
	Test		
		Installation	Control system simulation 60 second ramping up of flow velocity in m/s from 0 to programmed Max. flow cut off and subsequent 60 second ramping down All configured outputs will exhibit their programmed behaviour Test Mode: Yes/No
		Display	Display screen test routine
		Keypad	Keypad test routine
		Memory	Memory test routine Memory erase: Yes/No
		Peripherals	Unit temperature, time, date, clock
		Ultrasonics	Tests ultrasonic board and sensors
		Calibrate Pt 100s	Tests measured temperature and resistance
		Reset Pt 100s	Resets temperature inputs
	Settings		
		Date	Example: 18/11/2019
		Time	Example: 09:27:00
		Date format	Select from list ↑↓ • dd/mm/yy • mm/dd/yy • yy/mm/dd
		Language	Select from list (as available) ↑↓ English, German, French, Spanish, Russian
		Keypad sound	Yes/No
		Battery	Low warning: Yes/No Auto off timer: 1 ... 59 min
	Defaults		Load default settings (except date and time): Yes/No
Diagnostics			Shows measured temperature, available logger memory, battery charge level, battery voltage (V), remaining battery capacity (mAh) (cycle using <b>ENTER</b> )
Data logger			
		Interval	Enter logging interval in seconds: 0 ... 999 s
		Selection	Select from list ↑↓ <b>ENTER</b> selects, <b>0</b> deselects Up to ten variables may be logged
		Low memory	Warning output 0 ... 100 %
		Log download	Sends all logger data using serial port
		Log erase	Clears the logger
Serial comms			Serial communication

# KATflow 230

## COMMISSIONING

Main menu	Menu level 1	Menu level 2	Description/settings
		Mode	Select from list ↑↓ <ul style="list-style-type: none"> <li>• None</li> <li>• Printer (output every second of selected values)</li> <li>• Diagnostic</li> <li>• Download (send logger data using serial port)</li> <li>• Cal Test (laboratory calibration, not recommended for field or customer use)</li> </ul>
		Baud	Select from list ↑↓ <ul style="list-style-type: none"> <li>• 9 600 (default)</li> <li>• 19 200</li> <li>• 57 600</li> <li>• 115 200</li> </ul>
		Parity	Select from list ↑↓ <ul style="list-style-type: none"> <li>• None</li> <li>• Even (default)</li> <li>• Odd</li> </ul>
Scope			Option that can be selected in the main menu
			Shows the received acoustic pulse (see Section 5.11) and further data to evaluate the signal quality as an oscilloscope function

Table 12: Menu structure KATflow 230

## 5.2 Output configuration

There are two output connectors at the bottom of the KATflow 230 enclosure. One is for serial communication, the other provides process inputs and outputs using an expansion junction box (see Picture 16).

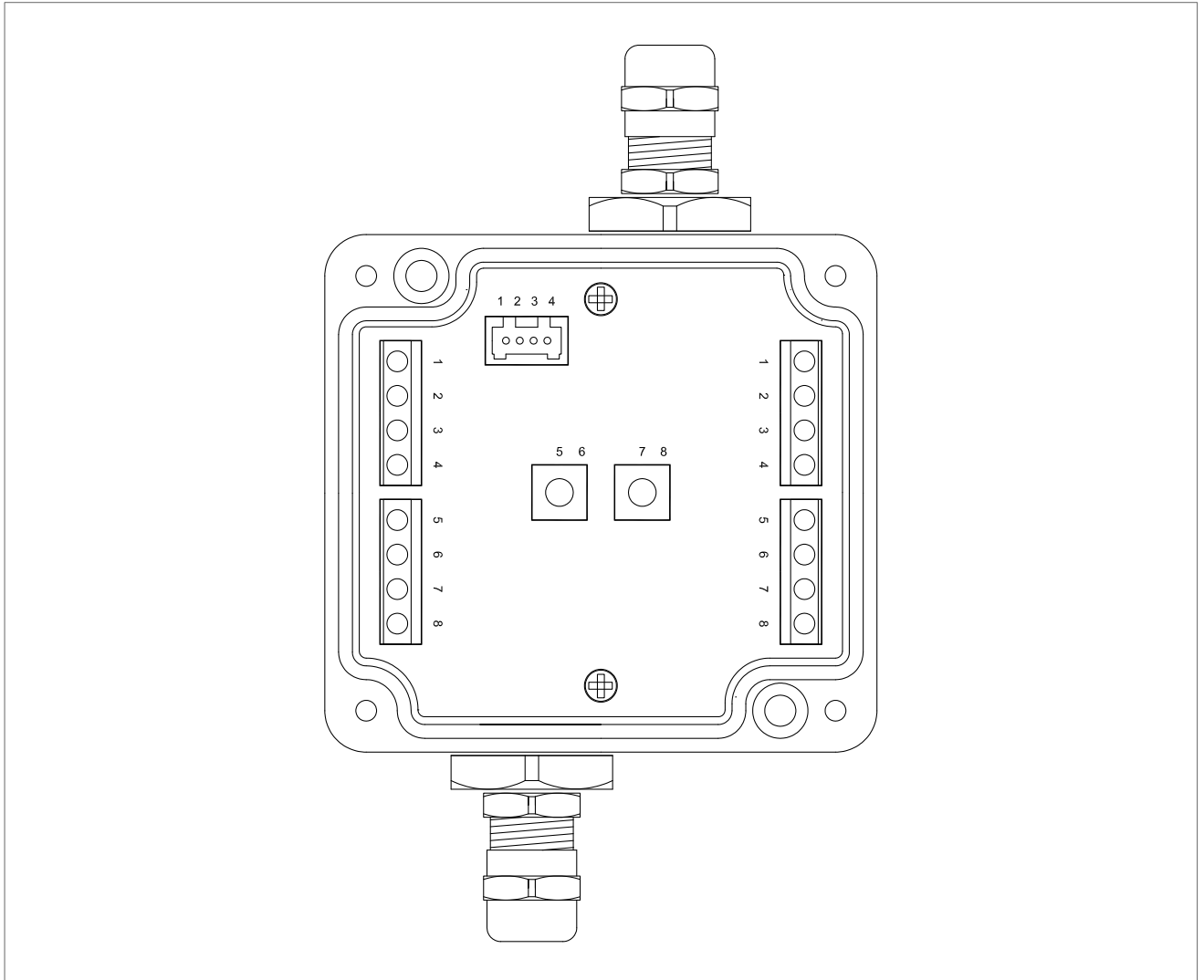

Picture 16: Process output box

The assignment of slots is detected by the flowmeter, and will be as shown in the “In/Output” menu. The following picture shows an example assignment with a passive current input on slot 1 (line 1) and an active current output on slot 2 (line 2).

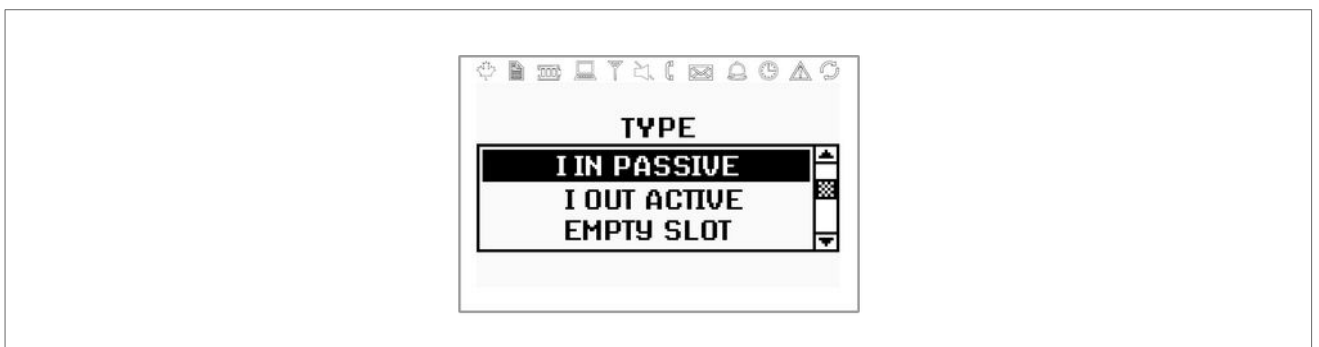

Picture 17: Display example passive current input

# KATflow 230

## COMMISSIONING

### 5.2.1 Serial interface

The RS 232 serial interface can be used to transmit data online or to download the integral data logger content. The settings can be found in the “Serial Communication” submenu.

The serial port can also be used to connect a further expansion box using modular input output cards (see Section 5.4).

### 5.2.2 Analogue current output 0/4 ... 20 mA

The analogue current outputs can be selected to operate in either 4 ... 20 mA mode or at 0 ... 20 mA across terminals 1, 2 and 4 in standard configuration. Two active analogue current outputs are installed as standard.



The current output can be programmed, scaled and assigned to flow channel 1 or 2 within the menu structure.

Active I out	
Electrical characteristics	<ul style="list-style-type: none"> <li>• 0/4 ... 20 mA active</li> <li>• Galvanically isolated from main electronics and from other inputs and outputs</li> <li>• Active: <math>U = 30\text{ V}</math>, <math>R_{\text{Load}} &lt; 500\ \Omega</math>, 16 bit resolution, accuracy: 0.1 % of measured value</li> </ul>

Table 13: Wiring analogue current output 0/4 ... 20 mA using expansion junction box

### 5.2.3 Digital relay output

The relay outputs are enabled, controlled and assigned to flow channel 1 or 2 using the menu structure. Digital outputs can be used as pulse, linear pulse frequency, and alarm/status outputs.

Relay	
Electrical characteristics	<ul style="list-style-type: none"> <li>• Galvanically isolated from main electronics and from other inputs and outputs</li> <li>• Function: Alarm or Totaliser</li> <li>• Totaliser value: 0.01 ... 1 000/unit</li> <li>• Width: 1 ... 990 ms</li> <li>• <math>U = 48\text{ V}</math>, <math>I_{\text{max}} = 250\text{ mA}</math></li> <li>• NO contacts</li> </ul>

Table 14: Wiring digital relay output using expansion junction box



### 5.2.4 Digital open-collector output

The digital open-collector output can be programmed, scaled and assigned to flow channel 1 or 2 within the menu structure. Digital outputs can be used as pulse, linear pulse frequency, and alarm/status outputs.

Optically switched relay "Open-Collector"	
Electrical characteristics	<ul style="list-style-type: none"> <li>Galvanically isolated from main electronics and from other inputs and outputs</li> <li>Function: Alarm or Totaliser</li> <li>Totaliser value: 0.01 ... 1000/unit</li> <li>Width: 1 ... 990 ms</li> <li><math>U = 24\text{ V}</math>, <math>I_{\text{max}} = 4\text{ mA}</math></li> <li>NO contacts</li> </ul>

Table 15: Wiring digital open-collector output using expansion junction box

## 5.3 Input configuration

There are two four-wire circuit Pt 100 inputs available at the bottom of the enclosure. Two further inputs are possible using the expansion box.

### 5.3.1 Pt 100 inputs

Wiring	Pt 100 option: four-wire circuit Plug connection
Electrical characteristics	<ul style="list-style-type: none"> <li>Galvanically isolated from main electronics and from other inputs and outputs</li> <li>Measurement range: <math>-50 \dots +400\text{ °C}</math> (<math>-58 \dots +752\text{ °F}</math>)</li> <li>Resolution: 0.01 K</li> <li>Accuracy: <math>\pm 0.02\text{ K}</math></li> </ul>

Table 16: Wiring Pt 100 inputs

# KATflow 230

## COMMISSIONING

### 5.4 Outputs using serial expansion box and modular cards

The KATflow 230 can further be equipped with an expansion box that connects to the serial port (see Picture 18). This box will accept standard Katronic modular input and output cards as listed below.



Please refer to our Customer Support to assist you in selecting and installing input and output cards for the expansion box.

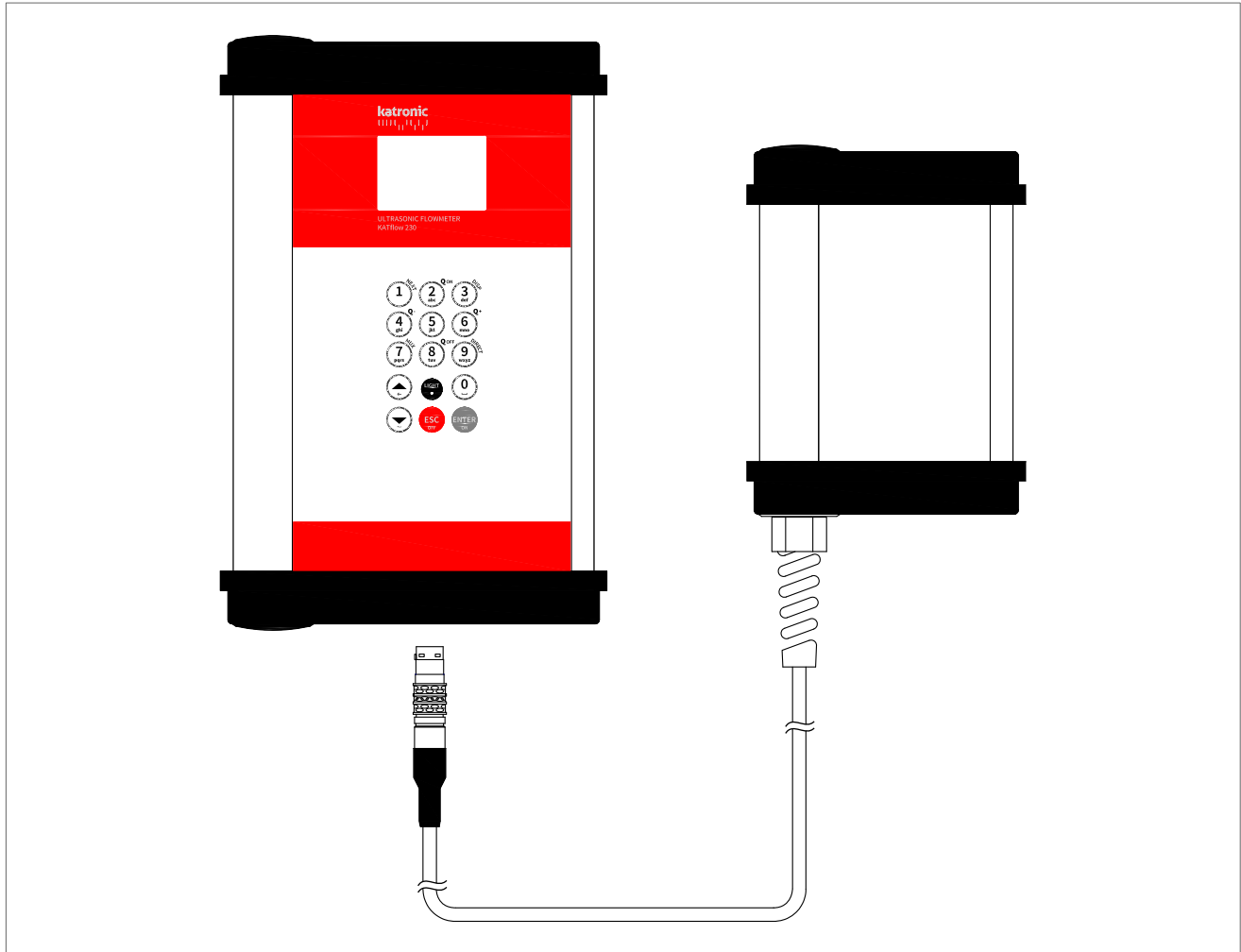

Picture 18: KATflow 230 with an expansion box configuration

## 5.4.1 Modbus RTU

The interface is used for networking up to 32 flowmeters to a centralised computer system. Each flowmeter is given an unique address to be able to communicate effectively. The communication protocol used conforms to the conventions of the Modbus RTU protocol, a description of which is given in a separate document. Please refer to Customer Support for further information.

<div style="display: flex; align-items: center;"> <div style="border: 1px solid black; padding: 2px; margin-right: 5px;">1</div> <div style="border: 1px solid black; padding: 2px; margin-right: 5px;">2</div> <div style="border: 1px solid black; padding: 2px; margin-right: 5px;">3</div> <div style="border: 1px solid black; padding: 2px;">4</div> </div> <p style="margin-top: 10px;">Modbus RTU slave</p>	<p>B</p> <p>A</p>		<p>Master device</p> <p>Terminating 100 Ω resistor</p>
	<p>Setup</p>	<p>Please refer to Customer Support.</p>	
	<p>Operation</p>	<p>Please refer to Customer Support.</p>	

Table 17: Wiring Modbus RTU

## 5.4.2 HART® compatible output

The KATflow 230 can also be configured with an optional module which responds to output commands conforming to the HART® protocol. Please refer to Customer Support for further information.

HART® is a registered trademark of the HART Communication Foundation.

<div style="display: flex; align-items: center;"> <div style="border: 1px solid black; padding: 2px; margin-right: 5px;">1</div> <div style="border: 1px solid black; padding: 2px; margin-right: 5px;">2</div> <div style="border: 1px solid black; padding: 2px; margin-right: 5px;">3</div> <div style="border: 1px solid black; padding: 2px;">4</div> </div> <p style="margin-top: 10px;">HART® compatible output (optional)</p>	<p>I-</p> <p>I+</p>		
<p>Electrical characteristics</p>	<ul style="list-style-type: none"> <li>Galvanically isolated from main electronics and from other inputs and outputs</li> <li>4 process variables selectable (PV, SV, TV and FV)</li> <li>Analogue: 4 ... 20 mA passive, <math>R_{Load} = 220 \Omega</math>, <math>U = 24 V</math>, accuracy: 0.1 % of measured value</li> </ul>		
	<p>Setup</p>	<p>Please refer to Customer Support.</p>	
	<p>Operation</p>	<p>Please refer to Customer Support.</p>	

Table 18: Wiring HART® compatible output

# KATflow 230

## COMMISSIONING

### 5.4.3 Analogue current output 0/4 ... 20 mA

The analogue current outputs operate in a 4 ... 20 mA or 0 ... 20 mA span.

Current outputs may be assigned to process values in the “Mode” section of the output menu. The outputs can be programmed and scaled within the menu structure.

<p>Active I out (optional)</p>		<p>I- ———— 30 V DC ————&gt; 0/4 ... 20 mA, load ≤ 500 Ω</p>
<p>Passive I out (optional)</p>		<p>I- ———— I+ ————&gt; 4 ... 20 mA, load ≤ 500 Ω</p>
<p>Electrical characteristics</p>	<ul style="list-style-type: none"> <li>• 0/4 ... 20 mA active and 4 ... 20 mA passive options</li> <li>• Galvanically isolated from main electronics and from other inputs and outputs</li> <li>• Active: U = 30 V, R<sub>Load</sub> &lt; 500 Ω, 16 bit resolution, accuracy: 0.1 % of measured value</li> <li>• Passive: U = 9 ... 30 V, R<sub>Load</sub> &lt; 500 Ω, 16 bit resolution, accuracy: 0.1 % of measured value</li> </ul>	

Table 19: Wiring analogue current output 0/4 ... 20 mA

### 5.4.4 Analogue voltage output 0 ... 10 V

Voltage outputs may be assigned to process values in the “Mode” section of the output menu. The outputs can be programmed and scaled within the menu structure.

<p>Volts out (optional)</p>		<p>V- ———— V+ ————&gt; 0 ... 10 V DC</p>
<p>Electrical characteristics</p>	<ul style="list-style-type: none"> <li>• Galvanically isolated from main electronics and from other inputs and outputs</li> <li>• Range: 0 ... 10 V</li> <li>• R<sub>Load</sub> = 1 kΩ, C<sub>Load</sub> = 200 pF</li> <li>• Resolution: 16 bit, accuracy: 0.1 % of measured value</li> </ul>	

Table 20: Wiring analogue voltage output 0 ... 10 V

### 5.4.5 Analogue frequency output (passive)

Frequency outputs may be assigned to process values in the “Mode” section of the output menu. The outputs can be programmed and scaled within the menu structure.

<p>Frequency (analogue output) (optional)</p>	
<p>Electrical characteristics</p>	<ul style="list-style-type: none"> <li>Galvanically isolated from main electronics and from other inputs and outputs</li> <li>2 Hz ... 10 kHz</li> <li><math>U = 24\text{ V}</math>, <math>I_{\text{max}} = 4\text{ mA}</math></li> </ul>

Table 21: Wiring analogue frequency output (passive)

### 5.4.6 Digital open-collector output

Open-collector outputs may be assigned to process values in the “Mode” section of the output menu. The outputs are configured using the menu structure.

The totaliser function is enabled and controlled using the menu structure.

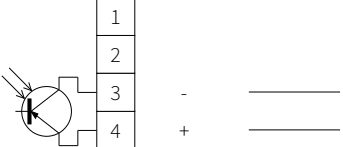
<p>Optically switched relay "Open-Collector" (optional)</p>	
<p>Electrical characteristics</p>	<ul style="list-style-type: none"> <li>Galvanically isolated from main electronics and from other inputs and outputs</li> <li>Function: Alarm or Totaliser</li> <li>Totaliser value: 0.01 ... 1 000/unit</li> <li>Width: 1 ... 990 ms</li> <li><math>U = 24\text{ V}</math>, <math>I_{\text{max}} = 4\text{ mA}</math></li> <li>NO and NC contacts</li> </ul>

Table 22: Wiring digital open-collector output

# KATflow 230

## COMMISSIONING

### 5.4.7 Digital relay output

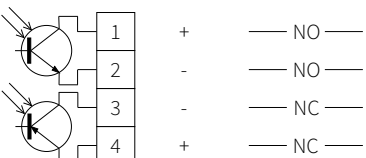
Relay outputs may be assigned to process values in the “Mode” section of the output menu. The relay outputs are configured using the menu structure.

Relay (optional)	
Electrical characteristics	<ul style="list-style-type: none"> <li>Galvanically isolated from main electronics and from other inputs and outputs</li> <li>Function: Alarm or Totaliser</li> <li>Totaliser value: 0.01 ... 1 000/unit</li> <li>Width: 1 ... 990 ms</li> <li>U = 48 V, I<sub>max</sub> = 250 mA</li> <li>NO and NC contacts</li> </ul>

Table 23: Wiring digital relay output

### 5.5 Inputs using serial expansion box and modular cards

#### 5.5.1 Pt 100 inputs

Temperature input Pt 100 3-wire (optional)	
Temperature input Pt 100 4-wire (optional)	
Electrical characteristics	<ul style="list-style-type: none"> <li>Pt 100 options: three- or four-wire circuit</li> <li>Galvanically isolated from main electronics and from other inputs and outputs</li> <li>Measurement range: -50 ... +400 °C (-58 ... +752 °F)</li> <li>Resolution: 0.01 K, accuracy: ±0.02 K</li> </ul>

Table 24: Wiring Pt 100 inputs

### 5.5.2 Analogue current input 0/4 ... 20 mA

Active analogue input (optional)	1	-		0/4 ... 20 mA, active input
	2	$I_{in}$		
	3	$I_{in}$		
	4	30 V DC		
Passive analogue input (optional)	1	-		4 ... 20 mA, passive input
	2	$I_{in}$		
	3	$I_{in}$		
	4	30 V DC		
Electrical characteristics	<ul style="list-style-type: none"> <li>• 0/4 ... 20 mA active or 4 ... 20 mA passive</li> <li>• <math>U = 30\text{ V}</math>, <math>R_i = 50\ \Omega</math>, accuracy: 0.1 % of measured value</li> </ul>			

Table 25: Wiring analogue current input 0/4 ... 20 mA

## 5.6 Temperature compensation

With temperature compensation enabled the temperature dependency of the medium in relation to speed of sound, viscosity and density calculations will be compensated. The “In/Output” menu will then allow the user to select the temperature input source, either Pt 100 temperature sensors or via a 0/4 ... 20 mA input channel.

## 5.7 Heat quantity measurement

Where equipped, heat quantity (energy) and heat flow (energy flow) can be measured. If a heat quantity unit is specified for the process value, the KATflow 230 will ask the user for the specific heat capacity of the medium in J/g/K (for example 4.186 J/g/K for water).

The output options menu for the Pt 100 will allow the user to select the temperature input source; either Pt 100 temperature sensors or a fixed value for measurement against a known inlet or outlet temperature. Where Pt 100 sensors are selected, the Wizard will prompt the user for a temperature offset, which may be useful where the temperature of the medium differs from the temperature of the pipe wall (for example with unlagged pipes). If a fixed value is selected, the user will be asked to specify this value.

When heat quantity units are selected, these behave as any other process value and may be totalised, logged, or applied to a process output.

## 5.8 Sound velocity measurement

The measured speed of sound (SOS) is available as a diagnostic function during measurement and may be applied to a process output by selecting “C” from the appropriate output menu.

## 5.9 Dual-channel flow calculations

Where suitably equipped, dual-channel calculations are available from the System - Calculation - Math menu. These allow the user to select the Sum, Difference, Average (mean) or Maximum of the two flow channels. This value may be displayed or applied to a process output by selecting “Math” from the appropriate output menu.

# KATflow 230

## COMMISSIONING

### 5.10 Wall thickness measurement

Optional sensor probes to measure pipe wall thickness (WTG) are available. The KATflow 230 will recognise a connected probe when entering the Setup or WTG Wizards, the measurement mode or the scope function. Use the Setup Wizard or “Installation” menu to set the pipe material. Select “Start Measurement”.

The KATflow 230 will recognise the probe and display the measurement screen. Wall thickness will be shown when the sensor is in good acoustic contact with the pipe.

#### 5.10.1 Wall Thickness Gauge Wizard

To confirm pipe thickness and sound speed, select the “WTG Wizard” from the “Quick Start” menu. Enter the approximate expected thickness as “Reference THK” and select “Calibrate”.

The screen displays the received acoustic pulse and values for the signal strength, the transit time, the reference thickness, the expected sound speed, the measured thickness at the reference sound speed and the measured sound speed at the reference thickness (top to bottom).

On leaving this screen using the **ESC** key, the flowmeter will ask if you wish to store the recorded value of longitudinal sound speed (“L-Speed” in the “Pipe” menu).

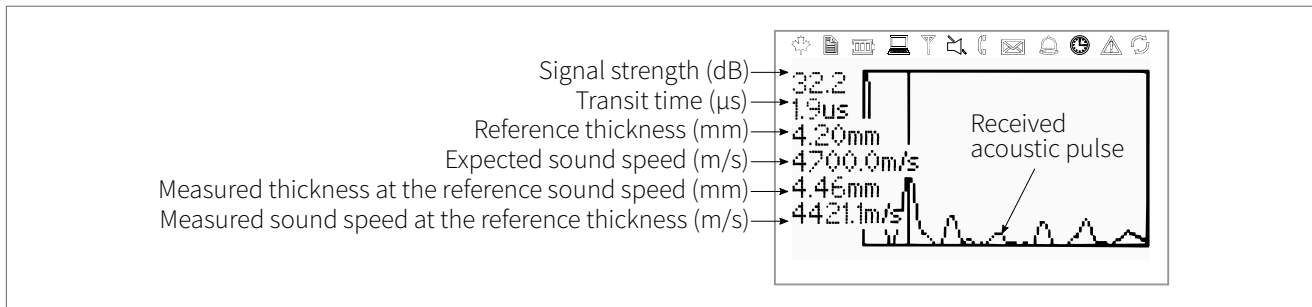

Picture 19: Wall Thickness Gauge (WTG) screen

### 5.11 Scope function

Katronic flowmeters have an additional scope function which shows a representation of the pulse received by the sensors on channel 1. In addition to displaying the received pulse, this screen lists the data given from top to bottom (see Picture 20).

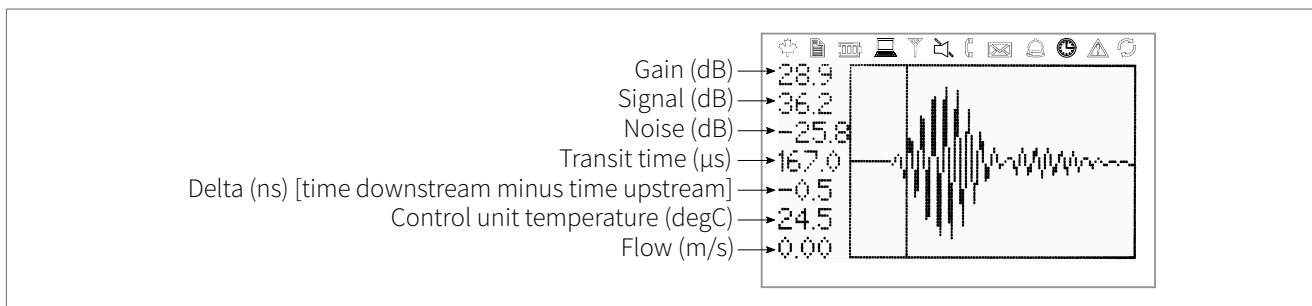

Picture 20: Scope function display

### 5.12 KATdata+ software

Software can be provided for downloading the contents of the data logger and communication with the flowmeter.



## 6 MAINTENANCE

KATflow flowmeters are maintenance free concerning the flow measurement functions. Within the scope of periodic inspections, regular inspection for signs of damage or corrosion is recommended for the transducers, the junction box (if installed) and the flowmeter housing.

### 6.1 Service/Repair

KATflow flowmeters have been carefully manufactured and tested. If installed and operated in accordance with the operating instructions, no problems are usually experienced.

Should you nevertheless need to return a device for inspection or repair, please pay attention to the following points:



- Due to statutory regulations on environmental protection and safeguarding the health and safety of our personnel, the manufacturer may only handle, test and repair returned devices that have been in contact with products without risk to personnel and environment.
- This means that the manufacturer can only service this device if it is accompanied by a Customer Return Note (CRN) confirming that the device is safe to handle.

If the device has been operated with toxic, caustic, flammable or water-endangering products, you are kindly requested:



- To check and ensure, if necessary by rinsing or neutralising, that all cavities are free from such dangerous substances,
- to enclose a certificate with the device confirming that is safe to handle and stating the product used.

# KATflow 230

## TROUBLESHOOTING

### 7 TROUBLESHOOTING

#### 7.1 Measurement difficulties and error messages

Most problems with measurement are due to poor signal strength or quality. Initial checks should include:

- Has sufficient acoustic coupling paste been applied?
- Can the number of sound passes be changed? As a general rule, more passes will improve accuracy, fewer passes will give better signal strength.
- Are there any nearby sources of noise or disturbance?
- Can the signal be improved by moving the sensors around the circumference of the pipe?
- Are the application parameters correct?

Should there be the need to call Customer Service, please let us know the following details:



- Model code,
- Serial number,
- SW, HW revision,
- Error log list.

Possible error messages may include the following:

Error message	Group	Description	Error handling
USB INIT FAIL	Hardware	Internal board communication error	Power on/off, otherwise call Customer Support
NO SERIAL NO.	Hardware	Failed to read from FRAM	Call Customer Support
NO VERSION NO.	Hardware	Failed to read from FRAM	Call Customer Support
PARA READ FAIL	Hardware	Failed to read from FRAM	Load defaults, otherwise call Customer Support
PARA WRITE FAIL	Hardware	Failed to write from FRAM	Load defaults, otherwise call Customer Support
VAR READ FAIL	Hardware	Failed to read from FRAM	Call Customer Support
VAR WRITE FAIL	Hardware	Failed to write from FRAM	Call Customer Support
SYSTEM ERROR	Hardware		Call Customer Support
VISIBILITY ERR	Hardware	Failed to read from FRAM	Call Customer Support
FRAM LONG WRITE ERR	Hardware	Failed to write from FRAM	Call Customer Support
FRAM READ ERR	Hardware	Failed to read from FRAM	Call Customer Support
RTC ERR	Hardware	Real Time Clock failure	Power on/off, otherwise call Customer Support
EXTMEM ERR	Hardware	Logger memory failure	Power on/off, otherwise call Customer Support
SPI ERR	Hardware	SPI bus failure	Power on/off, otherwise call Customer Support

Error message	Group	Description	Error handling
I2C ERR	Hardware	I2C bus failure	Power on/off, otherwise call Customer Support
MATH ERR	Software	Internal calculation error	Call Customer Support
STACK ERR	Software	Internal calculation error	Call Customer Support
ADDR ERR	Software	Internal calculation error	Call Customer Support
OSC ERR	Software	Internal calculation error	Call Customer Support
ADC ERR	Software	Internal calculation error	Call Customer Support
IO ERR	Software	Internal calculation error	Call Customer Support
TIMING ERR	Software	Internal calculation error	Call Customer Support
COMM INIT ERR	Hardware	Internal communication error	Power on/off, otherwise call Customer Support
COMM START ERR	Hardware	Internal communication error	Power on/off, otherwise call Customer Support
COMM HS0 ERR	Hardware	Internal communication error	Power on/off, otherwise call Customer Support
COMM HS1 ERR	Hardware	Internal communication error	Power on/off, otherwise call Customer Support
COMM READ AVE ERR	Hardware	Internal communication error	Power on/off, otherwise call Customer Support
COMM READ RAW ERR	Hardware	Internal communication error	Power on/off, otherwise call Customer Support
COMM READ HISTORY ERR	Hardware	Internal communication error	Power on/off, otherwise call Customer Support
COMM CRC ERR	Hardware	Internal communication error	Power on/off, otherwise call Customer Support
SENSOR COUPLING ERR	Application	Weak sensor coupling, low SNR	Recouple sensors, check installation, reduce number of passes, look for other location, otherwise call Customer Support

Table 26: Error list

# KATflow 230

## TROUBLESHOOTING

### 7.2 Data download difficulties

If difficulties are encountered downloading the logger data:

- Check that the flowmeter is switched on and not in measurement mode.
- Check that the same number COM port is allocated in the “Device Manager” (or equivalent) as is set in the KATdata+ software.
- Check that the settings (baud, parity, word length, stop bits) are identical.
- Use the supplied connectors – whether connecting to a 9-pin COM port or converting from serial communication to a Universal Serial Bus (USB).
- Is the logger in “Wrap Mode”? If “yes”, use a terminal program and the “Log Download” command. If “no”, the KATdata+ software may also be used.

## 8 TECHNICAL DATA

### 8.1 Sound speed of selected pipe materials

Material	Sound speed* shear wave (at +25 °C)	
	m/s	ft/s
Steel, 1 % Carbon, hardened	3 150	10 335
Carbon steel	3 230	10 598
Mild steel	3 235	10 614
Steel, 1 % Carbon	3 220	10 565
302 Stainless steel	3 120	10 236
303 Stainless steel	3 120	10 236
304 Stainless steel	3 141	10 306
304L Stainless steel	3 070	10 073
316 Stainless steel	3 272	10 735
347 Stainless steel	3 095	10 512
“Duplex” stainless steel	2 791	9 479
Aluminium	3 100	10 171
Aluminium (rolled)	3 040	9 974
Copper	2 260	7 415
Copper (annealed)	2 325	7 628
Copper (rolled)	2 270	7 448
CuNi (70 % Cu 30 % Ni)	2 540	8 334
CuNi (90 % Cu 10 % Ni)	2 060	6 759
Brass (Naval)	2 120	6 923
Gold (hard-drawn)	1 200	3 937
Inconel	3 020	9 909
Iron (electrolytic)	3 240	10 630
Iron (Armco)	3 240	10 630
Ductile iron	3 000	9 843
Cast iron	2 500	8 203
Monel	2 720	8 924
Nickel	2 960	9 712
Tin (rolled)	1 670	5 479
Titanium	3 125	10 253
Tungsten (annealed)	2 890	9 482
Tungsten (drawn)	2 640	8 661
Tungsten carbide	3 980	13 058
Zinc (rolled)	2 440	8 005
Glass (pyrex)	3 280	10 761
Glass (heavy silicate flint)	2 380	7 808
Glass (light borate crown)	2 840	9 318
Nylon	1 150	3 772
Nylon, 6-6	1 070	3 510
Polyethylene (LD)	540	1 772
PVC, CPVC	1 060	3 477
Acrylic resin	1 430	4 690
PTFE	2 200	7 218

Table 27: Technical data pipe material

\*Note these values are to be considered nominal. Solids may be inhomogeneous and anisotropic. Actual values depend on exact composition, temperature, and to a lesser extent, on pressure and stress.

# KATflow 230

## TECHNICAL DATA

### 8.2 Technical data of selected fluids

All data given at +25 °C (+77 °F) unless otherwise stated				Sound speed		Change of sound speed per °C		Viscosity (kinematic)			
Substance	Chemical formula	Density g · cm <sup>-3</sup>		m · s <sup>-1</sup>	ft · s <sup>-1</sup>	m · s <sup>-1</sup> · °C <sup>-1</sup>		mm <sup>2</sup> · s <sup>-1</sup>		10 <sup>-6</sup> · ft <sup>2</sup> · s <sup>-1</sup>	
Acetic acid, anhydride	(CH <sub>3</sub> CO) <sub>2</sub> O	1.082	20 °C	1 180.0	3 871.4		2.50	0.769		8.274	
Acetic acid, nitrile	C <sub>2</sub> H <sub>3</sub> N	0.783		1 290.0	4 232.3		4.10	0.441		4.745	
Acetic acid, ethyl ester	C <sub>4</sub> H <sub>8</sub> O <sub>2</sub>	0.901		1 085.0	3 559.7		4.40	0.467		5.025	
Acetic acid, methyl ester	C <sub>3</sub> H <sub>6</sub> O <sub>2</sub>	0.934		1 211.0	3 973.1			0.407		4.379	
Acetone	C <sub>3</sub> H <sub>6</sub> O	0.791		1 174.0	3 851.7		4.50	0.399		4.293	
Acetylene dichloride	C <sub>2</sub> H <sub>2</sub> Cl <sub>2</sub>	1.260		1 015.0	3 330.1		3.80	0.400		4.304	
Acetylene tetrachloride	C <sub>2</sub> H <sub>2</sub> Cl <sub>4</sub>	1.595		1 147.0	3 763.1		3.80	1.156	15 °C	12.440	15 °C
Alcohol	C <sub>2</sub> H <sub>6</sub> O	0.789		1 207.0	3 960.0		4.00	1.396		15.020	
Ammonia	NH <sub>3</sub>	0.771		1 729.0	-33 °C 5 672.6	-27 °C	6.68	0.292	-33 °C	3.141	-27 °F
Benzene	C <sub>6</sub> H <sub>6</sub>	0.879		1 306.0	4 284.8		4.65	0.711		7.650	
Benzol	C <sub>6</sub> H <sub>6</sub>	0.879		1 306.0	4 284.8		4.65	0.711		7.650	
Bromine	Br <sub>2</sub>	2.928		889.0	2 916.7		3.00	0.323		3.475	
n-Butane (2)	C <sub>4</sub> H <sub>10</sub>	0.601	0 °C	1 085.0	-5 °C 3 559.7	23 °C	5.80				
2-Butanol	C <sub>4</sub> H <sub>10</sub> O	0.810		1 240.0	4 068.2		3.30	3.239		34.851	
sec-Butylalcohol	C <sub>4</sub> H <sub>10</sub> O	0.810		1 240.0	4 068.2		3.30	3.239		34.851	
n-Butyl bromide (46)	C <sub>4</sub> H <sub>9</sub> Br	1.276	20 °C	1 019.0	20 °C 3 343.2	68 °F		0.490	15 °C	5.272	59 °C
n-Butyl chloride (22,46)	C <sub>4</sub> H <sub>9</sub> Cl	0.887		1 140.0	3 740.2		4.57	0.529	15 °C	5.692	59 °F
Carbon tetrachloride	CCl <sub>4</sub>	1.595	20 °C	926.0	3 038.1		2.48	0.607		6.531	
Carbon tetrafluoride (Freon 14)	CF <sub>4</sub>	1.750	-150 °C	875.2	-150 °C 2 871.5	-238 °F	6.61				
Chloroform	CHCl <sub>3</sub>	1.489		979.0	3 211.9		3.40	0.550		5.918	
Dichlorodifluoromethane (Freon 12)	CCl <sub>2</sub> F <sub>2</sub>	1.516	40 °C	774.1	2 539.7		4.24				
Ethanol	C <sub>2</sub> H <sub>6</sub> O	0.789		1 207.0	3 960.0		4.00	1.390		14.956	
Ethyl acetate	C <sub>4</sub> H <sub>8</sub> O <sub>2</sub>	0.901		1 085.0	3 559.7		4.40	0.489		5.263	
Ethyl alcohol	C <sub>2</sub> H <sub>6</sub> O	0.789		1 207.0	3 960.0		4.00	1.396		15.020	
Ethyl benzene	C <sub>8</sub> H <sub>10</sub>	0.867	20 °C	1 338.0	20 °C 4 890.8	68 °F		0.797	17 °C	8.575	63 °F
Ether	C <sub>4</sub> H <sub>10</sub> O	0.713		985.0	3 389.8		4.87	0.311		3.346	
Ethyl ether	C <sub>4</sub> H <sub>10</sub> O	0.713		985.0	3 231.6		4.87	0.311		3.346	
Ethylene bromide	C <sub>2</sub> H <sub>4</sub> Br <sub>2</sub>	2.180		995.0	3 264.4			0.790		8.500	
Ethylene chloride	C <sub>2</sub> H <sub>4</sub> Cl <sub>2</sub>	1.253		1 193.0	3 914.0			0.610		6.563	
Ethylene glycol	C <sub>2</sub> H <sub>6</sub> O <sub>2</sub>	1.113		1 658.0	5 439.6		2.10	17.208	20 °C	185.158	68 °F
Fluorine	F	0.545	-143 °C	403.0	-143 °C 1 322.2	-225 °F	11.31				
Formaldehyde, methyl ester	C <sub>2</sub> H <sub>4</sub> O <sub>2</sub>	0.974		1 127.0	3 697.5		4.02				
Freon R12				774.2	2 540.0		6.61				
Glycol	C <sub>2</sub> H <sub>6</sub> O <sub>2</sub>	1.113		1 658.0	5 439.6		2.10				
50 % Ethylene glycol/ 50 % Water				1 578.0	5 177.0						
Isopropanol	C <sub>3</sub> H <sub>8</sub> O	0.785	20 °C	1 170.0	20 °C 3 838.6	68 °F		2.718		29.245	
Isopropyl alcohol (46)	C <sub>3</sub> H <sub>8</sub> O	0.785	20 °C	1 170.0	20 °C 3 838.6	68 °F		2.718			

# KATflow 230

## TECHNICAL DATA

All data given at +25 °C (+77 °F) unless otherwise stated				Sound speed				Change of sound speed per °C		Viscosity (kinematic)			
Substance	Chemical formula	Density g · cm <sup>-3</sup>		m · s <sup>-1</sup>		ft · s <sup>-1</sup>		m · s <sup>-1</sup> · °C <sup>-1</sup>		mm <sup>2</sup> · s <sup>-1</sup>		10 <sup>-6</sup> · ft <sup>2</sup> · s <sup>-1</sup>	
Kerosene		0.810		1 324.0		4 343.8		3.60					
Methane	CH <sub>4</sub>	0.162	-89 °C	405.0	-89 °C	1 328.7	-128 °F	17.50					
Methanol	CH <sub>4</sub> O	0.791	20 °C	1 076.0		3 530.2		292.00		0.695		7.478	
Methyl acetate	C <sub>3</sub> H <sub>6</sub> O <sub>2</sub>	0.934		1 211.0		3 973.1				0.407		4.379	
Methyl alcohol	CH <sub>4</sub> O	0.791		1 076.0		3 530.2		292.00		0.695		7.478	
Methyl benzene	C <sub>7</sub> H <sub>8</sub>	0.867		1 328.0	20 °C	4 357.0	68 °F	4.27		0.644		7.144	
Milk, homogenised				1 548.0		5 080.0							
Naphtha		0.760		1 225.0		4 019.0							
Natural gas		0.316	-103 °C	753.0	-103 °C	2 470.5	-153 °F						
Nitrogen	N <sub>2</sub>	0.808	-199 °C	962.0	-199 °C	3 156.2	-326 °F			0.217	-199 °C	2.334	-326 °F
Oil, Car (SAE 20a.30)		1.740		870.0		2 854.3				190.000		2 045.093	
Oil, Castor	C <sub>11</sub> H <sub>10</sub> O	0.969		1 477.0		4 845.8		3.60		0.670		7.209	
Oil, Diesel		0.800		1 250.0		4 101.0							
Oil, Fuel AA gravity		0.990		1 485.0		4 872.0		3.70					
Oil (Lubricating X200)				1 530.0		5 019.9							
Oil (Olive)		0.912		1 431.0		4 694.9		2.75		100.000		1 076.365	
Oil (Peanut)		0.936		1 458.0		4 738.5							
Propane (-45 to -130 °C)	C <sub>3</sub> H <sub>8</sub>	0.585	-45 °C	1 003.0	-45 °C	3 290.6	-49 °F	5.70					
1-Propanol	C <sub>3</sub> H <sub>8</sub> O	0.780	20 °C	1 222.0	20 °C	4 009.2	68 °F						
2-Propanol	C <sub>3</sub> H <sub>8</sub> O	0.785	20 °C	1 170.0	20 °C	3 838.6	68 °F			2.718		29.245	
Propene	C <sub>3</sub> H <sub>6</sub>	0.563	-13 °C	963.0	13 °C	3 159.4	9 °F	6.32					
n-Propylalcohol	C <sub>3</sub> H <sub>8</sub> O	0.780	20 °C	1 222.0	20 °C	4 009.2	68 °F			2.549		27.427	
Propylene	C <sub>3</sub> H <sub>6</sub>	0.563	-13 °C	963.0	-13 °C	3 159.4	9 °F	6.32					
Refrigerant 11	CCl <sub>3</sub> F	1.490		828.3	0 °C	2 717.5	32 °F	3.56				8.500	
Refrigerant 12	CCl <sub>2</sub> F <sub>2</sub>	1.516	-40 °C	774.1	-40 °C	2 539.7	-40 °C	4.24					
Refrigerant 14	CF <sub>4</sub>	1.750	-150 °C	875.2	-150 °C	2 871.6	-268 °F	6.61					
Refrigerant 21	CHCl <sub>2</sub> F	1.426	0 °C	891.0	0 °C	2 923.2	32 °F	3.97					
Refrigerant 22	CHClF <sub>2</sub>	1.491	-69 °C	893.9	50 °C	2 923.2	32 °F	4.79					
Refrigerant 113	CCl <sub>2</sub> F- CClF <sub>2</sub>	1.563		783.7	0 °C	2 571.2	32 °F	3.44					
Refrigerant 114	CClF <sub>2</sub> - CClF <sub>2</sub>	1.455		665.3	-10 °C	2 182.7	14 °F	3.73					
Refrigerant 115	C <sub>2</sub> ClF <sub>5</sub>			656.4	-50 °C	2 153.5	-58 °F	4.42					
Refrigerant C318	C <sub>4</sub> F <sub>8</sub>	1.620	-20 °C	574.0	-10 °C	1 883.2	14 °F	3.88					
Sodium nitrate	NaNO <sub>3</sub>	1.884	336 °C	1 763.3	336 °C	5 785.1	637 °F	0.74		1.370	336 °C	14.740	637 °F
Sodium nitrite	NaNO <sub>2</sub>	1.805	292 °C	1 876.8	292 °C	6 157.5	558 °F						
Sulphur	S			1 177.0	250 °C	3 861.5	482 °F	-1.13					
Sulphuric Acid	H <sub>2</sub> SO <sub>4</sub>	1.841		1 257.6		4 126.0		1.43		11.160		120.081	
Tetrachloroethane	C <sub>2</sub> H <sub>2</sub> Cl <sub>4</sub>	1.553	20 °C	1 170.0	20 °C	3 838.6	68 °F			1.190		12.804	
Tetrachloroethene	C <sub>2</sub> Cl <sub>4</sub>	1.632		1 036.0		3 399.0							
Tetrachloromethane	CCl <sub>4</sub>	1.595	20 °C	926.0		3 038.1				0.607		6.531	
Tetrafluoromethane (Freon 14)	CF <sub>4</sub>	1.750	-150 °C	875.2	-150 °C	2 871.5	-283 °F	6.61					

# KATflow 230

## TECHNICAL DATA

All data given at +25 °C (+77 °F) unless otherwise stated				Sound speed				Change of sound speed per °C	Viscosity (kinematic)				
Substance	Chemical formula	Density g · cm <sup>-3</sup>		m · s <sup>-1</sup>		ft · s <sup>-1</sup>			m · s <sup>-1</sup> · °C <sup>-1</sup>	mm <sup>2</sup> · s <sup>-1</sup>		10 <sup>-6</sup> · ft <sup>2</sup> · s <sup>-1</sup>	
		Toluene	C <sub>7</sub> H <sub>8</sub>	0.867	20 °C	1 328.0	20 °C	4 357.0		68 °F	4.27		0.644
Toluol	C <sub>7</sub> H <sub>8</sub>	0.866		1 308.0		4 291.3		4.20		0.580		6.240	
Trichlorofluoromethane (Freon 11)	CCl <sub>3</sub> F	1.490		828.3	0 °C	2 717.5	32 °F	3.56					
Turpentine		0.880		1 255.0		4 117.5				1.400		15.064	
Water, distilled	H <sub>2</sub> O	0.996		1 498.0		4 914.7		-2.40		1.000		10.760	
Water, heavy	D <sub>2</sub> O			1 400.0		4 593.0							
Water, sea		1.025		1 531.0		5 023.0		-2.40		1.000		10.760	

Table 28: Technical data of fluids



### 8.3 Dependence between temperature and sound speed in water

Temperature		Sound speed in water	
°C	°F	m/s	ft/s
0	32.0	1 402	4 600
1	33.8	1 407	4 616
2	35.6	1 412	4 633
3	37.4	1 417	4 649
4	39.2	1 421	4 662
5	41.0	1 426	4 679
6	42.8	1 430	4 692
7	44.6	1 434	4 705
8	46.4	1 439	4 721
9	48.2	1 443	4 734
10	50.0	1 447	4 748
11	51.8	1 451	4 761
12	53.6	1 455	4 774
13	55.4	1 458	4 784
14	57.2	1 462	4 797
15	59.0	1 465	4 807
16	60.8	1 469	4 820
17	62.6	1 472	4 830
18	64.4	1 476	4 843
19	66.2	1 479	4 853
20	68.0	1 482	4 862
21	69.8	1 485	4 872
22	71.6	1 488	4 882
23	73.4	1 491	4 892
24	75.2	1 493	4 899
25	77.0	1 496	4 908
26	78.8	1 499	4 918
27	80.6	1 501	4 925
28	82.4	1 504	4 935
29	84.2	1 506	4 941
30	86.0	1 509	4 951
31	87.8	1 511	4 958
32	89.6	1 513	4 964
33	91.4	1 515	4 971
34	93.2	1 517	4 977
35	95.0	1 519	4 984
36	96.8	1 521	4 984
37	98.6	1 523	4 990
38	100.4	1 525	4 997
39	102.2	1 527	5 010
40	104.0	1 528	5 013
41	105.8	1 530	5 020
42	107.6	1 532	5 026
43	109.4	1 534	5 033
44	111.2	1 535	5 036
45	113.0	1 536	5 040
46	114.8	1 538	5 046
47	116.6	1 538	5 049
48	118.4	1 540	5 053
49	120.2	1 541	5 056
50	122.0	1 543	5 063

# KATflow 230

## TECHNICAL DATA

Temperature		Sound speed in water	
°C	°F	m/s	ft/s
51	123.8	1 543	5 063
52	125.6	1 544	5 066
53	127.4	1 545	5 069
54	129.2	1 546	5 072
55	131.0	1 547	5 076
56	132.8	1 548	5 079
57	134.6	1 548	5 079
58	136.4	1 548	5 079
59	138.2	1 550	5 086
60	140.0	1 550	5 086
61	141.8	1 551	5 089
62	143.6	1 552	5 092
63	145.4	1 552	5 092
64	147.2	1 553	5 092
65	149.0	1 553	5 095
66	150.8	1 553	5 095
67	152.6	1 554	5 099
68	154.4	1 554	5 099
69	156.2	1 554	5 099
70	158.0	1 554	5 099
71	159.8	1 554	5 099
72	161.6	1 555	5 102
73	163.4	1 555	5 102
74	165.2	1 555	5 102
75	167.0	1 555	5 102
76	167.0	1 555	5 102
77	170.6	1 554	5 099
78	172.4	1 554	5 099
79	174.2	1 554	5 099
80	176.0	1 554	5 099
81	177.8	1 554	5 099
82	179.6	1 553	5 095
83	181.4	1 553	5 095
84	183.2	1 553	5 095
85	185.0	1 552	5 092
86	186.8	1 552	5 092
87	188.6	1 552	5 092
88	190.4	1 551	5 089
89	192.2	1 551	5 089
90	194.0	1 550	5 086
91	195.8	1 549	5 082
92	197.6	1 549	5 082
93	199.4	1 548	5 079
94	201.2	1 547	5 076
95	203.0	1 547	5 076
96	204.8	1 546	5 072
97	206.6	1 545	5 069
98	208.4	1 544	5 066
99	210.2	1 543	5 063
100	212.0	1 543	5 063
104	220.0	1 538	5 046
110	230.0	1 532	5 026
116	240.0	1 524	5 000
121	250.0	1 516	5 007

Temperature		Sound speed in water	
°C	°F	m/s	ft/s
127	260.0	1 507	4 944
132	270.0	1 497	4 912
138	280.0	1 487	4 879
143	290.0	1 476	4 843
149	300.0	1 465	4 807
154	310.0	1 453	4 767
160	320.0	1 440	4 725
166	330.0	1 426	4 679
171	340.0	1 412	4 633
177	350.0	1 398	4 587
182	360.0	1 383	4 538
188	370.0	1 368	4 488
193	380.0	1 353	4 439
199	390.0	1 337	4 387
204	400.0	1 320	4 331
210	410.0	1 302	4 272
216	420.0	1 283	4 210
221	430.0	1 264	4 147
227	440.0	1 244	4 082
232	450.0	1 220	4 003
238	460.0	1 200	3 937
243	470.0	1 180	3 872
249	480.0	1 160	3 806
254	490.0	1 140	3 740
260	500.0	1 110	3 642

Table 29: Temperature and sound speed in water

# KATflow 230

## SPECIFICATION

### 9 SPECIFICATION

#### 9.1 General

Measuring principle	Ultrasonic time difference correlation principle
Flow velocity range	0.01 ... 25 m/s
Resolution	0.25 mm/s
Repeatability	0.15 % of measured value, $\pm 0.015$ m/s
Accuracy	Volume flow: $\pm 1 \dots 3$ % of measured value depending on application $\pm 0.5$ % of measured value with process calibration Flow velocity (mean): $\pm 0.5$ % of measured value
Turn down ratio	1/100
Gaseous and solid content of liquid media	< 10 % of volume

#### 9.2 Flowmeter

Enclosure type	Portable
Degree of protection	IP 65 according EN 60529
Operating temperature	-10 ... +60 °C (+14 ... +140 °F)
Housing material	Extruded aluminium, Al Mg Si 0.5, lids die-cast zinc alloy GD-Zn AL4 CU1
Measurement channels	1 or 2
Calculation functions	Average/difference/sum/maximum (dual-channel use only)
Power supply	Internal rechargeable batteries: 8 x NiMH AA 2850 mAh Power adapter: 100 ... 240 V AC input, 9 V DC output External battery pack: 12 V 105 Ah, 25 kg (optional)
Operating time	Up to 24 h with fully charged internal batteries
Display	LCD graphic display, 128 x 64 dots, backlit
Dimensions	266 (h) x 168 (w) x 37 (d) mm
Weight	Approx. 2 kg
Power consumption	< 5 W
Signal damping	0 ... 99 s
Transit time measurement rate	100 Hz (standard)
Output update time	1 s, faster rates on application
Operating languages	Czech, Dutch, English, French, German, Italian, Romanian, Russian, Spanish, Turkish (others on request)

### 9.3 Quantity and units of measurement

Volumetric flow rate	m <sup>3</sup> /h, m <sup>3</sup> /min, m <sup>3</sup> /s, l/h, l/min, l/s USgal/h (US gallons per hour), USgal/min, USgal/s bbl/d (barrels per day), bbl/h, bbl/min, bbl/s
Flow velocity	m/s, ft/s, inch/s
Mass flow rate	g/s, t/h, kg/h, kg/min
Volume	m <sup>3</sup> , l, gal (US gallons), bbl
Mass	g, kg, t
Heat flow	W, kW, MW (only with heat quantity measurement option)
Heat quantity	J, kJ, MJ (only with heat quantity measurement option)
Temperature	T <sub>in</sub> , T <sub>out</sub> , CU (housing temperature) in °C
Speed of sound	C in m/s
Signal quality	Sig in dB (signal), noise in dB, SNR (signal to noise ratio)

### 9.4 Internal data logger

Storage capacity	Approx. 30 000 measurements (each comprising up to 10 selectable measurement units), logger size 5 MB Approx. 100 000 measurements (each comprising up to 10 selectable measurement units), logger size 16 MB
Logging data	All measured and totalised values, parameter sets

### 9.5 Communication

Serial interface	RS 232
Data	Measured and totalised value, parameter set and configuration, logged data

### 9.6 KATdata+ software

Functionality	Download of measured values/parameter sets, graphical presentation, list format, export to third party software, online transfer of measured data
Operating systems	Windows 10, 8, 7, Vista, XP, NT, 2000, Linux

# KATflow 230

## SPECIFICATION

### 9.7 Process inputs



The KATflow 230 has four fixed installed internal process outputs: two active current outputs, one open-collector output and one relay output. Furthermore, there are two Pt 100 four-wire circuit temperature inputs. A maximum of two additional input and output slots can be used with the expansion box. All process outputs are galvanically isolated from the device electronics and from other inputs/outputs.

Temperature	Pt 100, three- or four-wire circuit Measurement range: -50 ... +400 °C (-58 ... +752 °F) Resolution: 0.01 K, accuracy: ±0.02 K
Current	0/4 ... 20 mA active or 4 ... 20 mA passive, U = 30 V, R <sub>i</sub> = 50 Ω, accuracy: 0.1 % of measured value



Further process inputs available on application.

### 9.8 Process outputs



The KATflow 230 has four fixed installed internal process outputs: two active current outputs, one open-collector output and one relay output. Furthermore, there are two Pt 100 four-wire circuit temperature inputs. A maximum of two additional input and output slots can be used with the expansion box. All process outputs are galvanically isolated from the device electronics and from other inputs/outputs.

Current	0/4 ... 20 mA active and 4 ... 20 mA passive options Active: U = 30 V, R <sub>Load</sub> < 500 Ω, 16 bit resolution, accuracy: 0.1 % of measured value Passive: U = 9 ... 30 V, R <sub>Load</sub> < 500 Ω, 16 bit resolution, accuracy: 0.1 % of measured value
Digital open-collector	Function: Alarm or Totaliser Totaliser value: 0.01 ... 1 000/unit, width: 1 ... 990 ms, U = 24 V, I <sub>max</sub> = 4 mA, NO and NC contacts
Digital relay	Function: Alarm or Totaliser Totaliser value: 0.01 ... 1 000/unit, width: 1 ... 990 ms, U = 48 V, I <sub>max</sub> = 250 mA, NO and NC contacts



Further process outputs available on application.

9.9 Sensors: K1L, K1N, K1E

Sensor type	K1L	K1N	K1E
Pipe diameter range	50 ... 6 500 mm	50 ... 3 000 mm	50 ... 3 000 mm
Temperature range	-30 ... +80 °C (-22 ... +176 °F)	-30 ... +130 °C (-22 ... +266 °F)	-30 ... +250 °C (-22 ... +482 °F) (for short periods up to +300 °C (+572 °F))
Material of cable conduits	PVC	Stainless steel	Stainless steel
Standard cable lengths	5.0 m	4.0 m	4.0 m
Dimensions of sensor heads	60 (h) x 30 (w) x 34 (d) mm		
Material of sensor heads	Stainless steel		
Degree of protection	IP 66 according to EN 60529 (IP 67 and IP 68 on request)		

9.10 Sensors: K4L, K4N, K4E

Sensor type	K4L	K4N	K4E
Pipe diameter range	10 ... 250 mm	10 ... 250 mm	10 ... 250 mm
Temperature range	-30 ... +80 °C (-22 ... +176 °F)	-30 ... +130 °C (-22 ... +266 °F)	-30 ... +250 °C (-22 ... +482 °F) (for short periods up to +300 °C (+572 °F))
Material of cable conduits	PVC	Stainless steel	Stainless steel
Standard cable lengths	5.0 m	2.5 m	2.5 m
Dimensions of sensor heads	43 (h) x 18 (w) x 22 (d) mm		
Material of sensor heads	Stainless steel		
Degree of protection	IP 66 according to EN 60529 (IP 67 and IP 68 on request)		

# KATflow 230

## INDEX

### 10 INDEX

Acoustic coupling gel	19	Modbus RTU	36, 43
Analogue current input	35, 47	Multiple sensors	15
Analogue current output	33, 40, 44	Negative separation distance	15
Analogue frequency output	34, 45	Outer pipe diameter	26
Analogue voltage output	34, 44	Output configuration	39
Battery charging	22, 25	Packaging	5, 8
Certificate of Conformity	65	Passes	15, 20, 27, 32, 33, 50, 51
Commissioning	31	Pipe material selection	11, 26, 31, 33, 48, 53
Contrast	23	Pipe parameters	19
Customer Return Note (CRN)	6, 49, 66	Pipe preparation	14
Data download difficulties	52	Process value	28, 47
Data logger	22, 25, 30, 37, 40, 48, 61	Pt 100 inputs	41, 46, 62
Diagnostic displays	22, 28-30	Quick Start	26, 28, 31, 48
Diagnostics	14, 37	Relay output	35, 40, 46, 62
Diagonal mode	15, 19, 27	Retaining clip (sensor mounting)	21
Digital relay output	35, 40, 46	Return policy	5, 6
Dimensions	16, 60, 63	RS 232	25, 40
Display	23, 25, 26, 28-30, 33, 37, 39, 48, 60	Safety	5, 6, 49
Display icons	25	Scope function	48
Disturbance sources	12, 14	Sensor configuration	15
Dual-channel calculations	47	Sensor location	11, 20, 21
Electrical connections	18	Sensor mounting	9, 12, 15, 19, 21
Error messages	50	Sensor positioning screen	20, 21, 27
Expansion box	40-42, 46, 62	Sensor separation	20, 21
Fluid selection	27	Serial interface	40, 61
Fluid temperature	27, 31	Setup Wizard	26, 27, 31, 48
HART® compatible output	36, 43	Software KATdata+	30, 48, 52, 61
Heat quantity measurement	47, 61	SOS (speed of sound)	31, 47
Identification of components	9	Sound velocity measurement	47
Inner pipe diameter	27	Specification	60
Input configuration	41	Storage	5, 8, 61
Installation	5, 6, 8, 11, 12, 16, 19, 28, 32, 37, 48, 51	Switching on/off	22
Junction box	39-41, 49	System configuration	10
Keypad	23, 24, 27, 32, 37	Temperature compensation	47
Legislative requirements	6	Three-line display	28
Liner material	27, 32	Totaliser	23, 24, 28-30, 40, 41, 45, 46, 62
Maintenance	49	Transit-time method	7
Maths functions	30, 31, 33-36, 47, 51	Troubleshooting	5, 50
Measurements	7, 11, 12, 26, 27, 61	Units of measurement	61
Measuring principle	7, 60	Wall thickness	9, 11, 15, 20, 26, 27, 31, 33, 48
Menu structure	29, 31, 38, 40, 41, 44-46	Wall thickness measurement	9, 48
		Warranty	5, 6
		Wizard (Quick Setup Wizard)	26, 27, 31, 48



11 APPENDIX A – CERTIFICATE OF CONFORMITY



**Declaration of Conformity**

We, Katronic Technologies Ltd., declare under our sole responsibility that the product listed below to which this declaration relates are in conformity with the EU directives:

- EMC Directive 2014/30/EU for Electromagnetic Compatibility
- Low Voltage Directive 2014/35/EU for Electrical Safety

Name of Products	Description
KATflow 100, 150, 200, 210 and 230	Ultrasonic flowmeter with associated Katronic transducers

The mentioned products are in conformity with the following European Standards:

Class	Standard	Description
EMC Directive	BS EN 61326-1:2013	Electrical equipment for measurement, control and laboratory use – EMC requirements
Immunity	BS EN 61326-1:2013	Electrical equipment for continuous unattended use
	BS EN 61000-4-2:2009	Electrostatic discharge
	BS EN 61000-4-3+A2:2006	RF field
	BS EN 61000-4-4:2012	Electric fast transient/burst
	BS EN 61000-4-5+A1:2014	Surge
	BS EN 61000-4-6:2014	RF conducted
Emission	BS EN 61000-4-11+A1:2004	AC mains voltage dips and interruption
	BS EN 61326-1:2013	Electrical equipment Class B
Low Voltage Directive	BS EN 55022:2010	Disturbance voltage Class B
	BS EN 61010-1:2010	Safety requirements for electrical equipment for measurement, control and laboratory use

Coventry, 1 November 2019

For and on behalf of Katronic Technologies Ltd.

Yours sincerely,

Andrew Sutton  
Managing Director

